



A division of Masonite International

AN OPEN DOOR ON STYLE, FLEXIBILITY AND DURABILITY.



WOOD DOOR COLLECTION

WWW.TRICONTRUSS.CA

INNOVATION

Innovation is synonymous with Lemieux Doors. We're an ideal synthesis of technology and dynamism, proudly defining the leading edge. And Lemieux is in a state of constant evolution, offering unparalleled competitiveness and value through efficient, streamlined operations. The Lemieux Doors team is focused on creating the highest quality products – and we consider it to be an asset without compare.

Featured on the cover
Door: Douglas Fir C311 IG DH
Sidelight: Douglas Fir 1702 IG
Transom: Douglas Fir Sunburst IG

WWW.TRICONTRUSS.CA



A division of Masonite International



Door: Torrefied Mahogany (with Cherry stain)
1510 w/ wide muntins & beveled IG
Sidelights: C1010 Transoms: 1 lite w/ beveled IG

WWW.TRICONTRUSS.CA

LEMIEUX DOORS COLLECTION

Choice & Selection. Words used all too often by home decoration manufacturers and retailers when, in fact, there isn't much to choose from. However, as you'll soon discover, if any company is the embodiment of these two words, it's Lemieux Doors.

Satisfaction – it all comes down to choice. Your choice. Wood, glass – panel design, shape, color, finish, texture, and even the way your door is built. We could probably make a different door an hour for an entire decade before making the same door twice. Far more than embody the concepts of choice & selection, we've completely redefined them.

However there's one thing Lemieux Doors doesn't offer any choice on – quality. Regardless of how you custom-design your door, or what method of fabrication and assembly fits your lifestyle or pocketbook, quality, and the best product warranties in the industry come standard with every single door we make. Lemieux Doors really has opened the door on style, flexibility and durability. Now it's time to cross our threshold and explore the infinite possibilities...

WWW.TRICONTRUSS.CA



A division of Masonite International



Door: Pine (with Cherry stain)
508 arch/arch DH w/ LVL stiles

WWW.TRICONTRUSS.CA



FRENCH DOORS 28



56 LOUVERS & BIFOLDS



LE CHATEAU 34



58 ROUTER CARVED MDF



62 ARTISAN

PERSONALIZE YOUR DOOR 8
LVL & WOOD CORE 12
TORREFIED 13
FIRE-RATED 14
A BLUEPRINT FOR EXCELLENCE 16
WOOD SELECTION 20
GLASS OPTIONS 24
FRENCH DOORS 28
LE CHATEAU 34
LOUVERS & BIFOLDS 56
ROUTER CARVED MDF 58
ARTISAN 62
TRANSOMS & SIDELIGHTS 66

PERSONALIZE YOUR DOOR

Lemieux Doors is recognized as the premiere maker of custom-designed top-quality doors. But that didn't happen by accident. Since our inception, we've dedicated ourselves to creating doors that outlast the elements, endure the years, and have a timeless quality that weather even the frequent temperamental changes in trends and styles.

It's only through the use of advanced methods of fabrication and the highest quality materials that our stellar reputation has emerged. A relentless attention to detail, the dogged pursuit of excellence, and the absolute refusal to be second best have always been our driving force – and where our competitors have been known to cut corners, we've gone the extra mile. That Lemieux Doors look great is a given. But it's what goes into each and every one of them that has truly made them the envy of the industry.

CHOOSE A DOOR STYLE

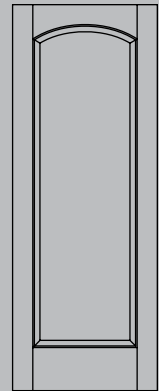

CHOOSE A PANELING DESIGN

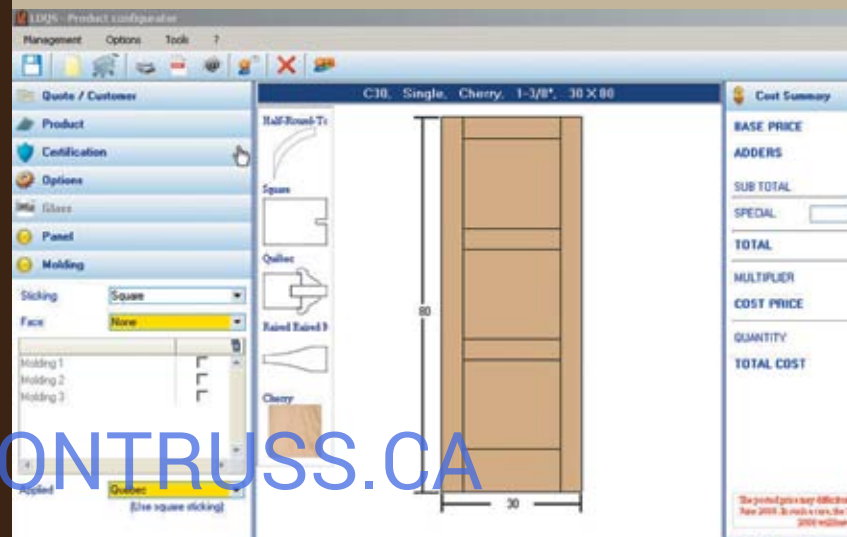
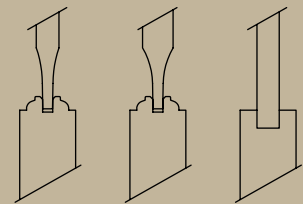

CHOOSE
A STAIN-GRADE
SPECIES

CHOOSE
A TOP

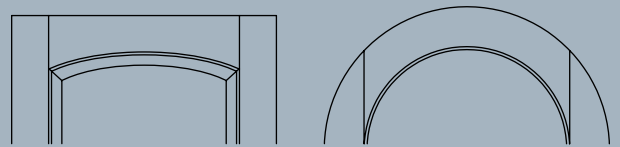

CHOOSE
A MOULDING

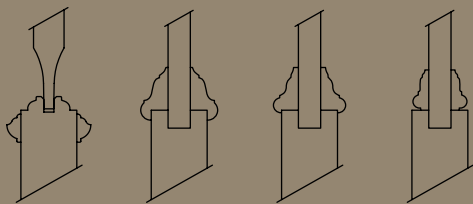

CHOOSE
A GLAZING

ALL THAT'S LEFT TO ADMIRE ARE THE
EXCEPTIONAL RESULTS. IT'S THAT EASY.

With our modular approach to customizing and design, creating a door that's both an attractive, harmonious extension of your décor, and one you can call your own, has never been easier. We're also developing new ways to process estimates with our exclusive Lemieux Doors Quoting System (LDQS). We've designed our world so that yours is easier to live in, and we're convinced that better doors will always lead the way into better buildings.

IMAGINATION COMES TO LIFE



Special designed doors (reference this page when ordering)

10 LEMIEUX DOORS

WWW.TRICONTRUSS.CA



Door: Maple 1504



Door: Knotty Alder C30 arch/arch
(center panel design not available)

WWW.TRICONTRUSS.CA

BEST PRICE WITH PERFORMANCE

LVL CORE TECHNOLOGY



Laminated Veneer Lumber (LVL). The name instills a sense of robustness and durability. LVL derives its strength from an impressive number of tightly bonded wood veneers, glued together layer upon layer, forming a solid tension-resistant core. Since the layers of veneer are arranged on edge, our LVL core withstands all tendency to warp and twist. It's a small detail that makes a big difference, and the advantages of employing this proven design allows us to avoid using weaker MDF as a core material. Our competition doesn't use LVL because it costs more. But Lemieux understands that the benefits of a longer lasting, better built product far outweigh the higher cost. **Every LVL doors comes with a solid 20-year warranty against warping.** Available in all species, panels, glasses and design.



MOST COST COMPETITIVE

WOOD CORE

Wood, pound for pound it's stronger than steel! It's impressively resilient and is better suited to shock and stress than many other building materials. But more than being merely solid and an ideal component in any quality door, wood is natural. Lemieux Doors obtains all of its wood from ecologically sustainable sources, so what goes in to making sure the great outdoors stays *out there* – also goes into keeping it vibrant and able to be enjoyed for generations to come.

Our wood-core doors carry with them all of those qualities wood is renowned for – and one that's sure to please your bottom line. Economy. It's probably the most competitively priced option available with a quality-to-price ratio that's nothing short of enviable. That's an advantage anyone can appreciate.



HIGHEST PERFORMANCE AVAILABLE

TORREFIED SOLID WOOD



PREMIUM EXTERIOR WOOD DOORS AVAILABLE IN SELECT GRADE ASPEN, DOUGLAS FIR, MAHOGANY AND POPLAR

CHEMICAL FREE TECHNOLOGY **THERE'S NEVER BEEN A DOOR THIS GOOD. EVER.**

Torrefication is an all-natural green process whereby wood is heated over time in order to eliminate its tendency to rot. It also makes wood far more structurally stable, and highly resistant to heat, cold, and moisture!

A 20-YEAR WARRANTY THAT'S AS DURABLE AS TIME. **SO, MOTHER NATURE... BRING IT ON!**

Every Torrefied Series exterior wood door carries a 20-year guarantee against warping, twisting, rotting or delamination! Who knows, it may even outlast your home!

UNLIMITED POSSIBILITIES UNLIMITED DESIGNS

The Torrefied Series is available in each of Lemieux's 10,000+ design options – and our 4/0 maximum widths and 8/0 heights are fully guaranteed, with available matching exterior jambs, brickmoulding and T-astragals.

IT'S OVER WITH OVERHANGS!

This may be the first time a door of comparable quality can be installed without the usual overhang requirements. A door built to face up to the elements; direct sunlight and extreme heat and cold. What's more it can be stained or painted in dark tints! **For the 20-year warranty to be honored, all six sides of the door must be sealed and maintained.**



TESTED TO THE EXTREME!

We stop at nothing to design a better door. In fact, we've been subjecting one of our doors to a daily deluge of abuse since October 2010 – and we're still waiting for the twisting, warping or rotting to show.

WWW.TRICONTRUSS.CA



Door: C22A V-Grooved Knotty Alder DH

FIRE-RATED

Lemieux carries a full line of fire-rated doors and jambs. They range from 20 (negative and positive), 60, and 90-minute-rated models, in sizes up to 4/0 width and 8/0 height, and are available in a range of custom sizes and designs, with either a primed paint finish, or a choice of 16 different species of stain grade.

Benefit from the advantages of using a single source for all your fire-rated door requirements. Our doors and jambs fit with a quality and durability nothing short of enviable. It's no longer a choice between form and function, because Lemieux's fire-rated door products afford your clients the peace of mind they need, and the great looks they want.

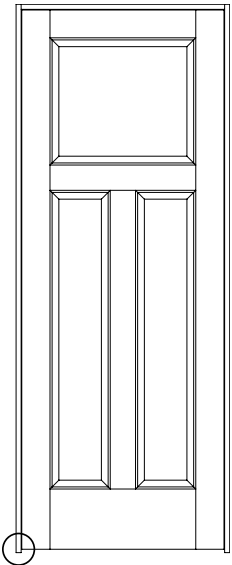

Fire-rated door and frame

FIRE-RATED DOOR SPECIFICATIONS

Rating	Cat.	Maximum size opening				Panel profile	Prefit	Available top rail selection	Standards compliance
		Single		Pairs					
		Width	Height	Width	Height				
20	A	48"	96"	84"	96"	Flat, Raised (SH), V-groove (SH & DH)	0°: Prefit ≤ 1/4 3°: 3° - 0" only	Arch, Classic, Half-Arch, Half-Classic, Half-Round, Round-Round, Round-Top, Square	Both positive and neutral, UL 10(c), UBC 7-2 (1997) Part 1, NFPA 252, ASTM E2074-00
	B	48"	96"	N/A	N/A				
60	A	48"	96"	84"	96"	Flat, Raised (SH), V-groove (SH & DH)	0°: Prefit ≤ 1/4 3°: 3° - 0" only		
90	A	48"	96"	N/A	N/A	Flat, Raised (SH), V-groove (SH & DH)	0°: Prefit ≤ 1/4 3°: 3° - 0" only	Both positive and neutral, UL 10(c), UBC 7-2 (1997) Part 1, NFPA 252, ASTM E2074-01, ASTM E152-81a	

Category A Lemieux Doors' category A doors are manufactured with a sealing system concealed into the edges of the door. This means that no additional edge-sealing system is required between the door and frame.

Category B These doors require an additional edge-sealing system between the door and frame.

WWW.TRICONTRUSS.CA

A BLUEPRINT FOR EXCELLENCE

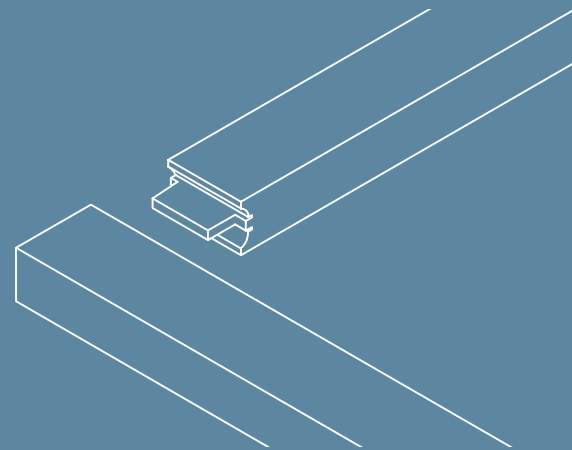
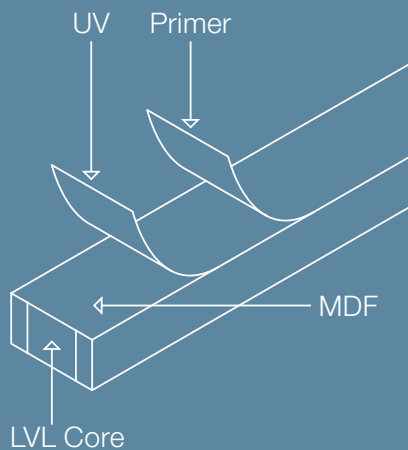

UV SEALANT ON PRIMED PRODUCTS

Our proprietary UV coating process guarantees every door is delivered ready-to-paint, soon to be transformed into an aesthetically pleasing component of any building design. We apply two coats of UV sealer in order to achieve a smooth door surface, before factory priming. The result is one of the smoothest primed finishes you'll find in the industry, and an extraordinary door.

VENEER PANELING

Our standard veneer panels carry a lifetime warranty against splitting, so you know light won't leak, drafts won't blow, and paint or stains won't show. Nor will these panels ever bow, cup, or warp!

MORTISE AND TENON CONSTRUCTION

It's as versatile as it is strong – superior to typical dowel assembly, mortise and tenon construction permits a continuous bond for much higher adhesion – plus, on-site trimming becomes a snap!

BEST QUALITY GLUES

Our engineering team spares no effort and is constantly on the watch for the best gluing/bonding technologies. For each application a very specific type of glue is used, ensuring the most effective adhesion. Glues used at Lemieux Doors are also used for heavy-duty structural applications such as bridges and multi-story buildings. Each and every Lemieux door is manufactured in our state-of-the-art production facility and is the result of countless hours of research and development.

Lemieux Doors Collection boasts a variety of high-grade wood species, precision handcrafted using vertical stiles and horizontal rails in your choice of panels and/or glass, ready to stain or paint. Stile & rail construction offers virtually limitless door styles, configurations, panel and sticking profiles.

PANEL/STICKING OPTIONS

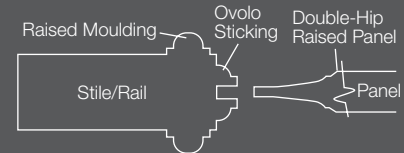
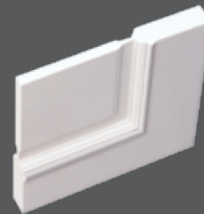
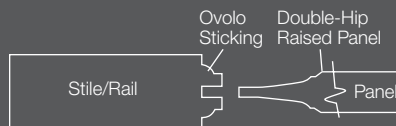
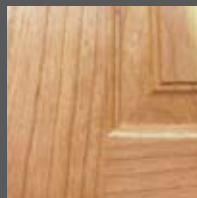
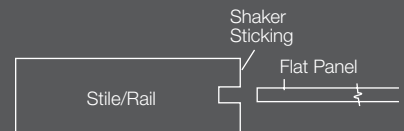
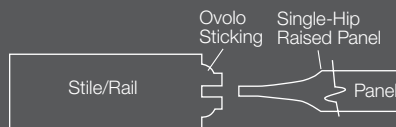
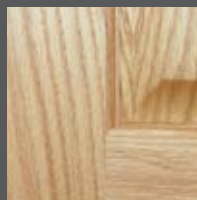

Raised moulding available only on square-top primed MDF doors.

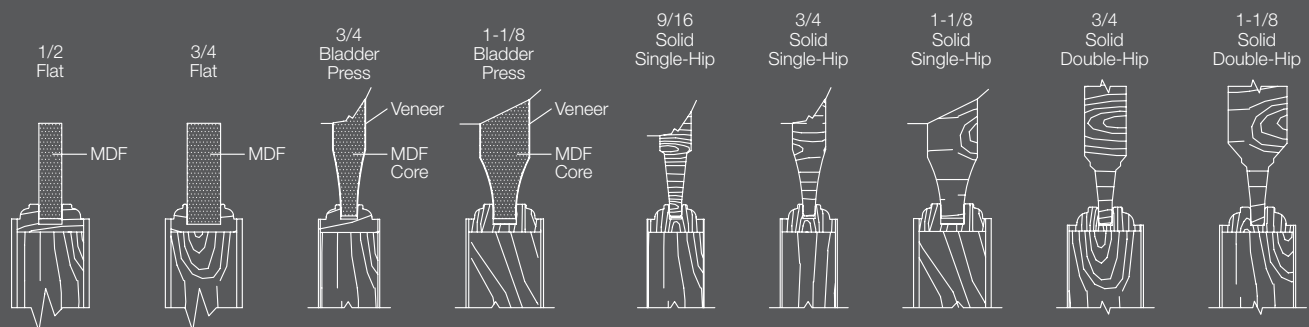

STILE & RAIL DOORS DEFINED

MULLION: narrow vertical sections between panels **MUNTIN:** slim vertical pieces used to separate panes of glass; grille bar **PANEL:** pieces that fit within the surrounding stile & rail frame that come in different profile designs – single-hip, double-hip and flat **RAIL:** horizontal pieces of the door; includes top, bottom and sometimes lock rails **STICKING:** the design of the profile edge on the stile and rail; ovolo is carved and rounded; shaker is straight and squared **STILE:** vertical pieces of the door



Round-Top



Segmented

DOOR TOPS

Cap off any Lemieux door with a crown befitting a king – no longer limited to a straight top, you can indulge in a semi-circular or arched-top doors. Either of which will make a door step out of the ordinary, and into the limelight.



Door: Torrefied Mahogany C11 arch/arch flat panel with Sherbrooke applied moulding

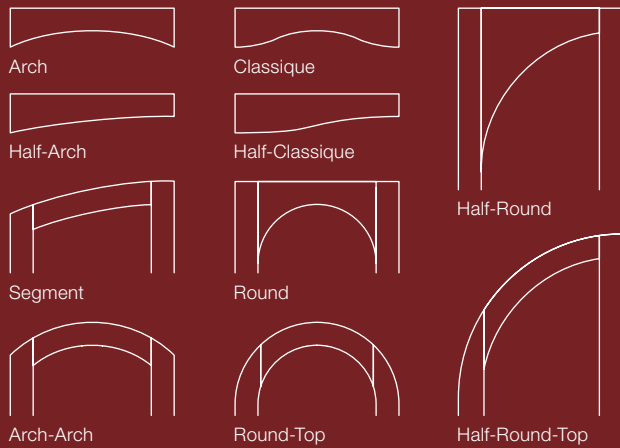

TOP RAIL

Your imagination is the only limit to creating the look you've always wanted and the key to creating a home that is truly unique. Turn yours into a space that will be envied and admired. With all the options available for glass, panels, wood specie, designs, and applied mouldings – it's only fitting to cap it all off with a touch of class and elegance.



PANELS

An interior or exterior door panel adds a distinctive finishing touch to any door, and allows you to better integrate its appearance into your design. It's all about aesthetic harmony, and making each door much more than an unassuming entrance.

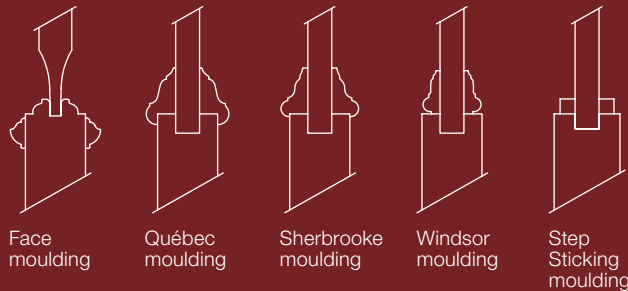

APPLIED MOULDINGS

A door can truly come alive when you add depth with our relief-accentuating mouldings. Transform a simple door into a structural element with dimensional impact and an impressive distinction. Lemieux offers 4 types of applied mouldings, and they're an easy way to leave your impression on a building decor. They allow you to sign each door with excellence, creating surfaces with daring and definition.

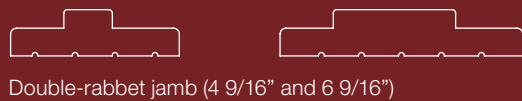

Double-rabbet jamb (4 9/16" and 6 9/16")



Single-rabbet jamb (4 9/16" and 6 9/16")



Flat jamb (4 9/16" and 6 9/16")

INTERIOR JAMBS AND EXTERIOR FRAMES FOR RADIUS AND ARCH TOP DOORS ONLY

Because we also carry a full line of interior jambs and exterior frames for radius and arch top doors, every component of your door design originates from the same source. Gone are the annoying structural and aesthetic incompatibilities that can arise from multi-sourced materials. Our turnkey solutions are designed to fit, last, and of course, to impress.

WOOD SELECTION

The suppleness of maple, the warmth of pine, the richness of mahogany – your choice of wood can make all the difference. What matters is that it suits your tastes and style, and achieves the effect you're looking for. Lemieux Doors prides itself on offering an impressive selection of woods that adapt gracefully to any decor and give your home an irresistible ambiance.

We've traveled the world so that we might bring you the best, managed-forest woods available. Responsible forest management is an important part of our philosophy, and ensures access to a renewable supply for years to come. That's more than can be said for resource depleting materials like steel, and fiberglass!

Lemieux offers 17 attractive stain-grade species and, excluding the double-primed variety, are all 100% stain grade. And because we've standardized the use of the stain-grade species across all our products, Lemieux's applied moldings, jambs, and fire-rated doors can be perfectly matched to any other of our components.



Knotty Alder



Ash



Aspen

**TORREFIED
AVAILABLE**



White Birch



Cherry



VG Douglass Fir

**TORREFIED
AVAILABLE**

WOOD SELECTION

Hemlock

Hickory Natural

Red Oak

White Oak

Pine

Poplar

**TORREFIED
AVAILABLE**



Mahogany

**TORREFIED
AVAILABLE**



Maple

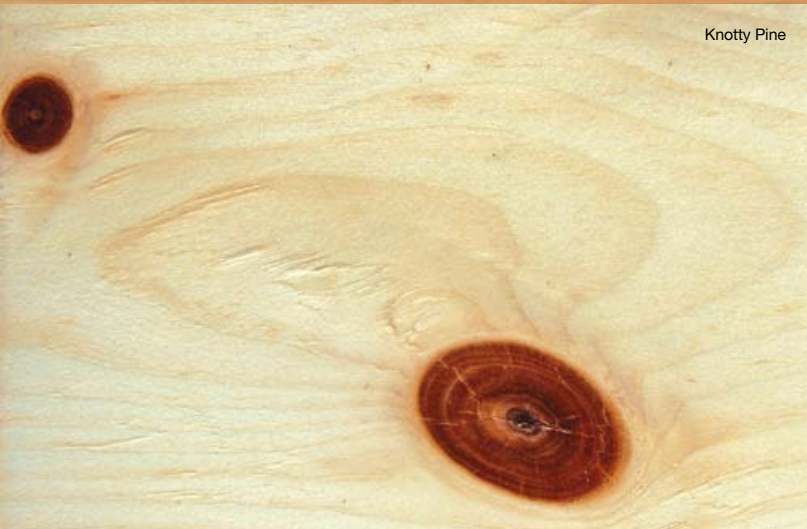

Knotty Pine



Clear Pine



Walnut

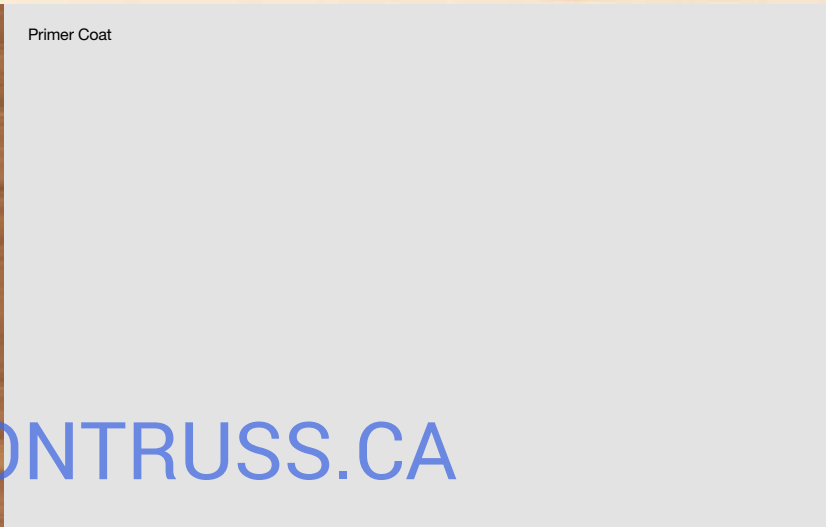

Primer Coat

GLASS OPTIONS

With over 63 varieties of glazing, Lemieux offers the widest array of any door manufacturer. From crystal-clear, to frosted and semi-opaque, patterned or plain – we'll custom-build doors that will work in harmony with your plans, enhancing your design intention and make any building worthy for inclusion into the proudest architectural portfolios. Incorporating the right exterior door into your designs offers numerous advantages – and Lemieux provides two essential glazing technologies:

LOW-E

The added bonus lies in the properties of low-E glass; the ability to eliminate the damaging effects of UV radiation on carpets, furnishings and upholstery.

INSULATED GLASS

Our high-quality reduced-thermal-emissivity glass not only reflects back solar heat in summer, and retains it in winter, but helps reduce exterior noise and eliminate potential condensation. So the buildings you design are not only energy-efficient, they're more comfortable and economical.

Arctic



Artique



Austin

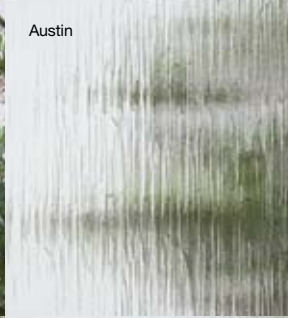

Autumn



Bamboo



Bronze Tint

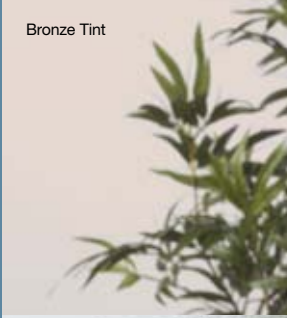

Bubbles



Chantilly



Charcoal Sticks



Clear Beveled



Contora



Cord



Corteza



Cross Reeded (small)



Crystal Ice



Delta Frost



Digital



Dots



Everglade



Flemish



Florex



Florielle



Fontana



Glacier



Glass Block



GLASS OPTIONS



Oak



Obscured (pinhead)



Obscured (pinhead) Beveled



Pelerine



Quarter Reed



Rain



Rain Water



Rough Rolled



Sandblast (frosted)



Satin (clear)



Satin Etched



Seedy Baroque



Taffeta



Thin Ribbed

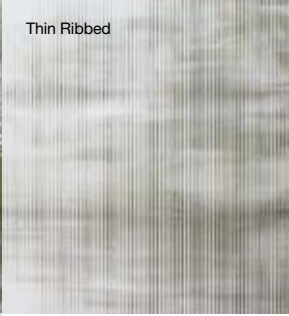

Warwick



Waterglass



White Celsius

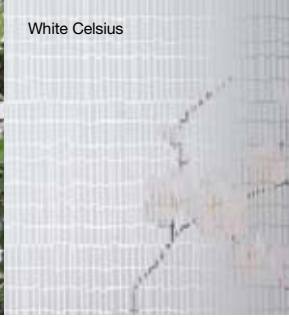

White Laminated (clear laminated available)





Door: Douglas Fir 5001 w/ LVL stiles

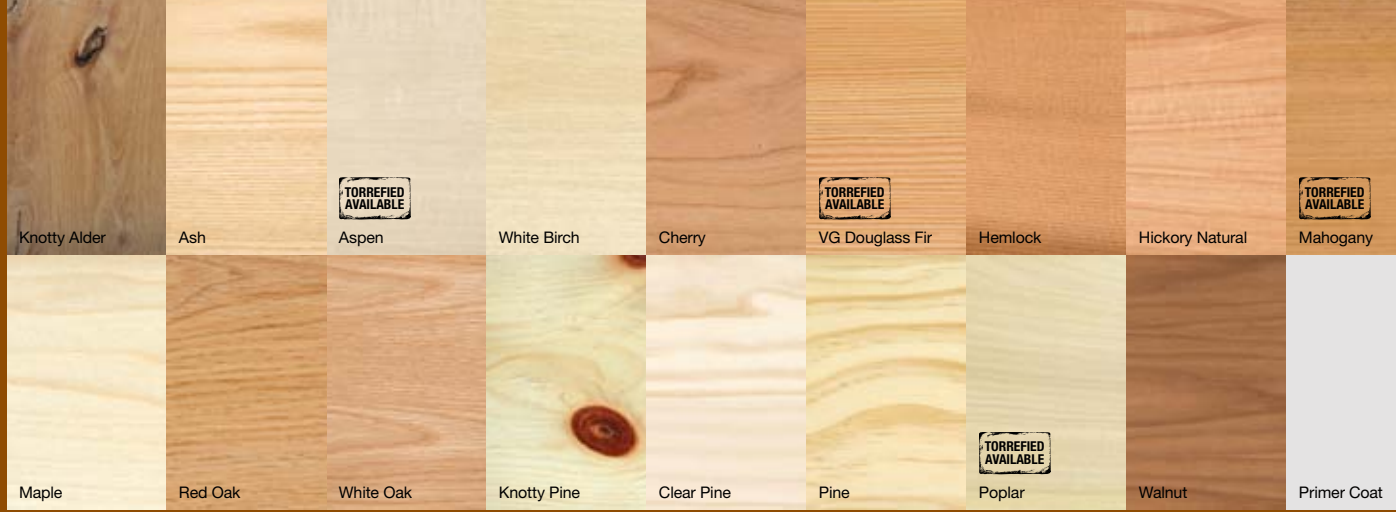

FRENCH DOORS COLLECTION

This is a company that prides itself on its specialty for exceptional French doors. We avoid the use of nails and staples using a clamp-glazed method perfected by Lemieux in 1992, resulting in a clean, unblemished finish. It's an innovation that's had a definite impact, and helped Lemieux Doors become a leader in North American French door sales. Time-tested mortise & tenon construction, and a pioneering UV sealer system all contribute to the production of these outstanding French doors.

Explore our wide range of glazing on pages 24 to 27.



Door: 1510 Primed

30 LEMIEUX DOORS

WWW.TRICONTRUSS.CA

FRENCH DOORS



1501



1505



1509

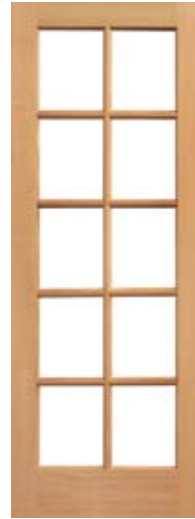

1510



1510A



1510C



1515



1515A



1515C



C30 W/GLAZING



C40 W/GLAZING



C55 W/GLAZING



LAUNDRY



PANTRY



WINE CELLAR



1515 Primed IG w/ Glacier glass and LVL stiles

32 LEMIEUX DOORS

WWW.TRICONTRUSS.CA

FRENCH DOORS

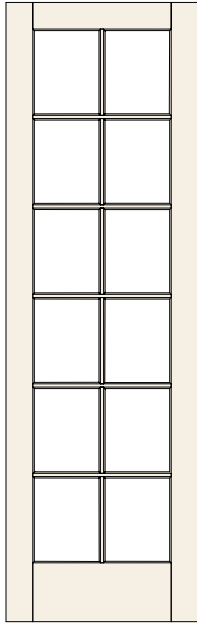

1512

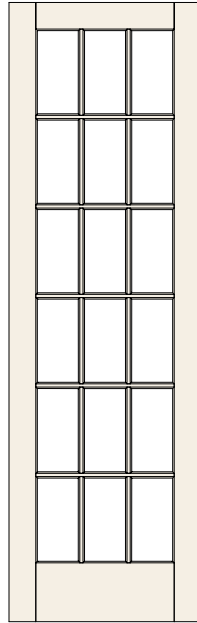

1518

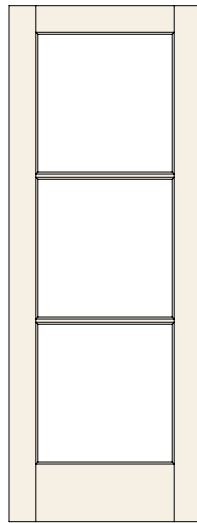

1503

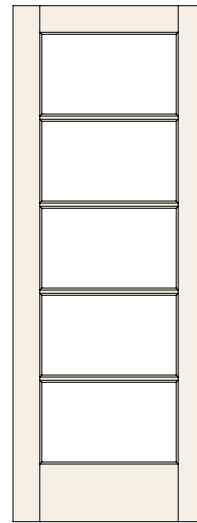

1505

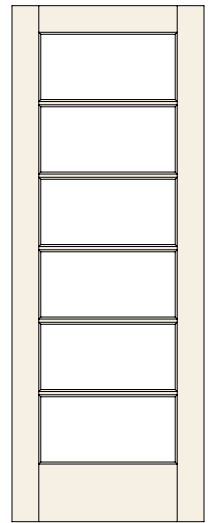

1506

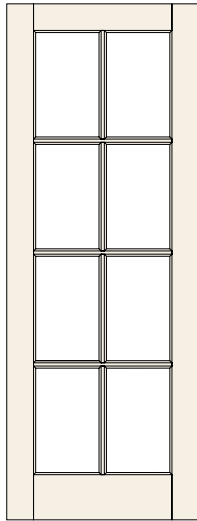

1508

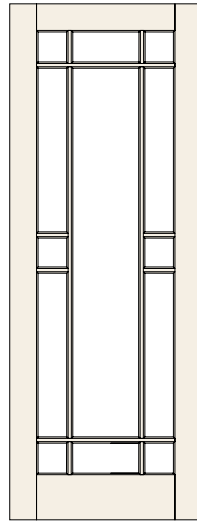

1513

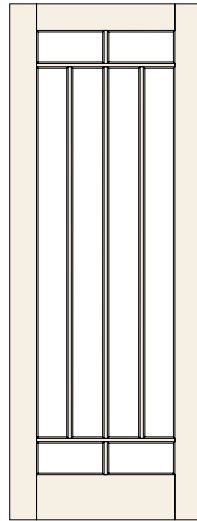

1514

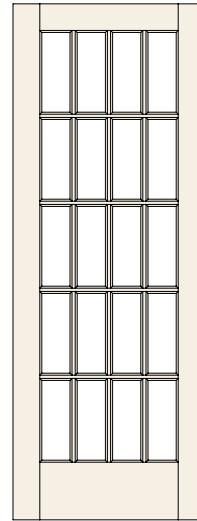

1520

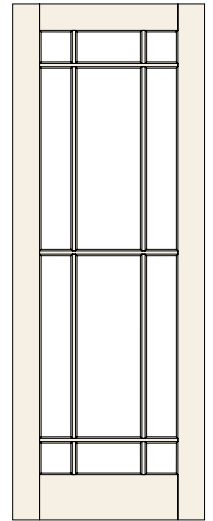

1523

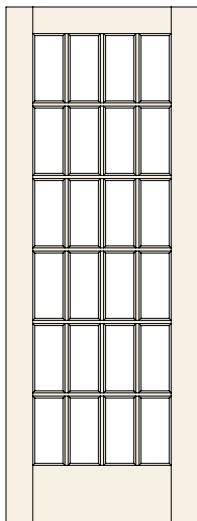

1524

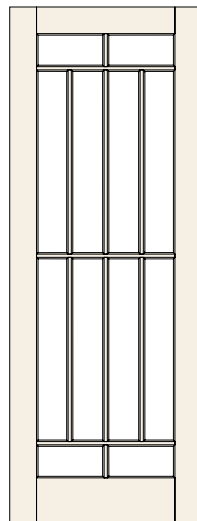

1529

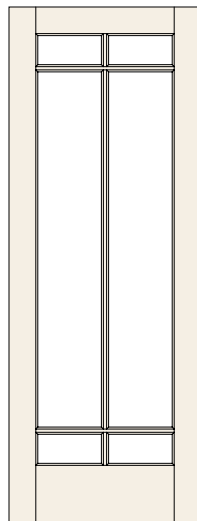

1596

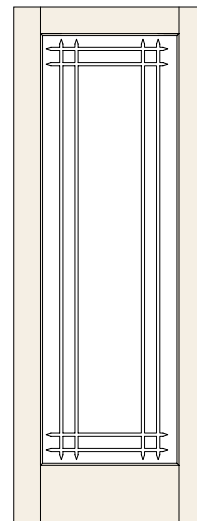

1509 V-groove

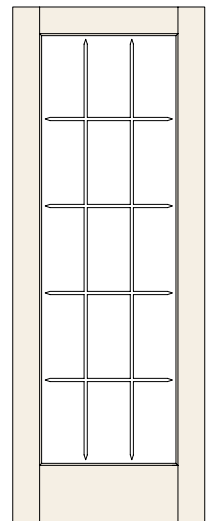

1515 V-groove



Door: Torrifed Mahogany C66

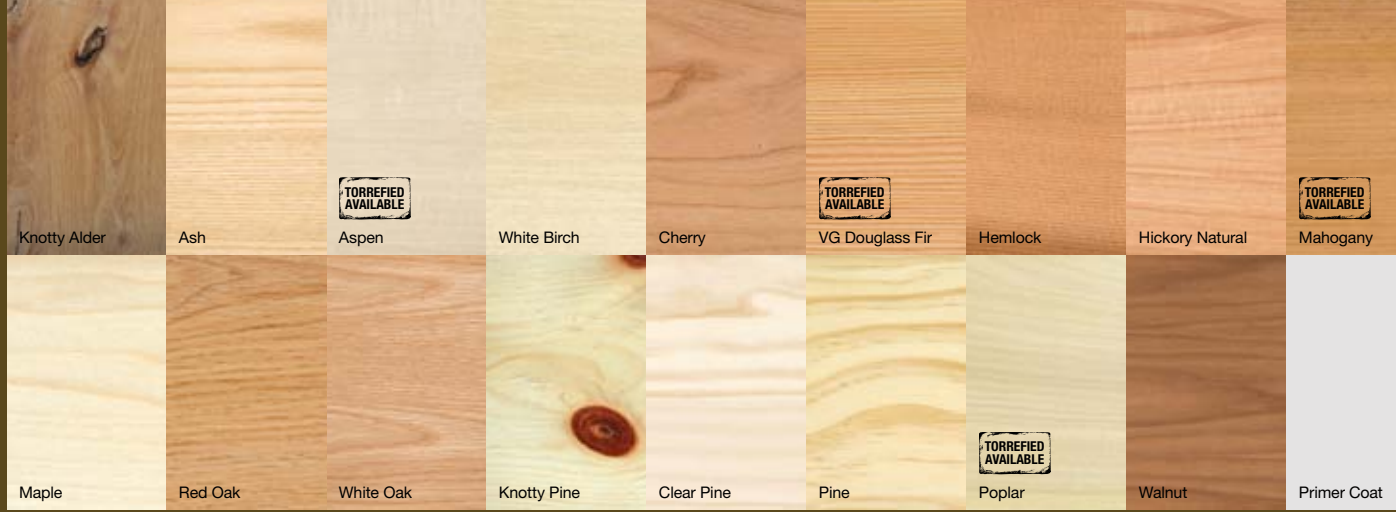

LE CHATEAU COLLECTION

This stunning collection of panelled doors is available in an almost endless range of design combinations, each of which will add undeniable sense of elegance and distinction to any room. Constructed from MDF panelling for increased strength and stability, these doors are resistant to cracks and leaks caused by thermal expansion and contraction. Advanced engineering of rails and stiles creates a door that is not only lighter, but requires no special screws for installation.

Enjoy a sense of added depth and heightened impact by adding distinctive applied mouldings to any Le Chateau door.



C22A Douglas Fir DH

C22 V-Grooved
Knotty Alder DH

C30 Hemlock BP

C33C Poplar BP

C35 Cherry
(flat and square)

C55 Pine
(Flat and Square)

WWW.TRICONTRUSS.CA



Door: Torrefied Poplar C24
Sidelights: Torrefied Polar 506 Cathedral w/ beveled IG
Transom: Custom (reference this page)

WWW.TRICONTRUSS.CA

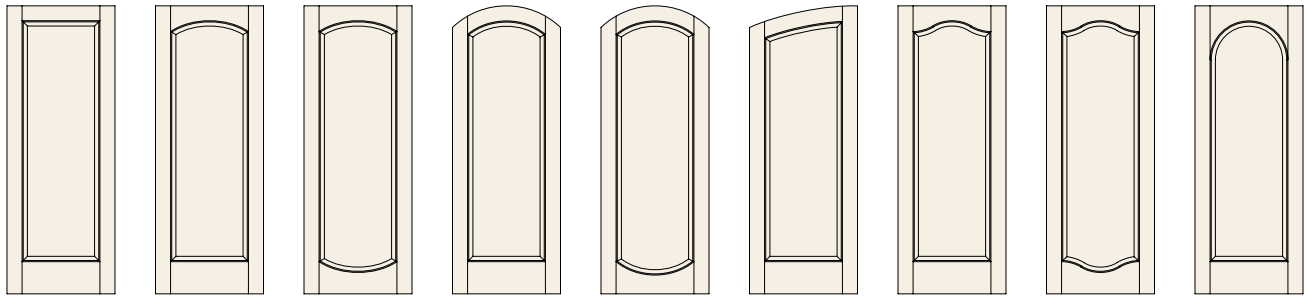

C11 C11-A C11-AB C11-AA C11-AAB C11-S C11-CL C11-CLB C11-R

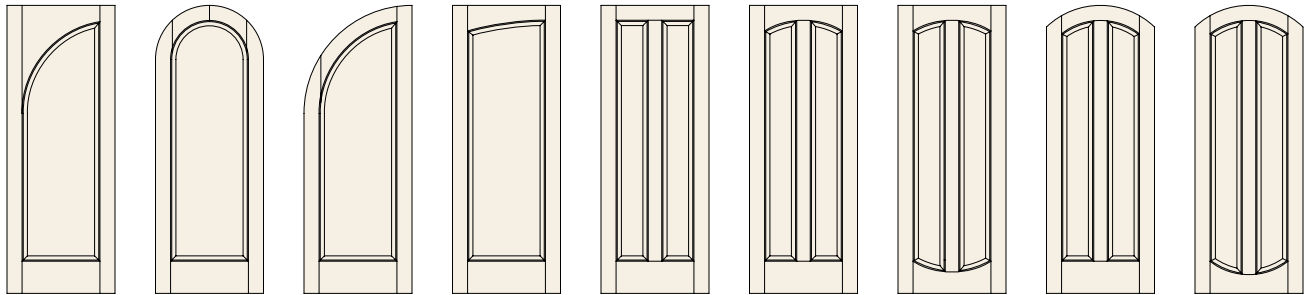

C11-HR C11-RT C11-HRT C11-HA C21 C21-A C21-AB C21-AA C21-AAB

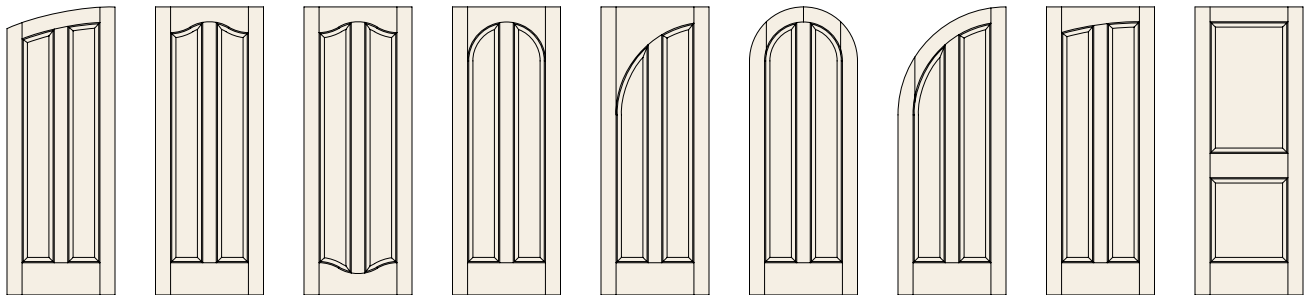

C21-S C21-CL C21-CLB C21-R C21-HR C21-RT C21-HRT C21-HA C22

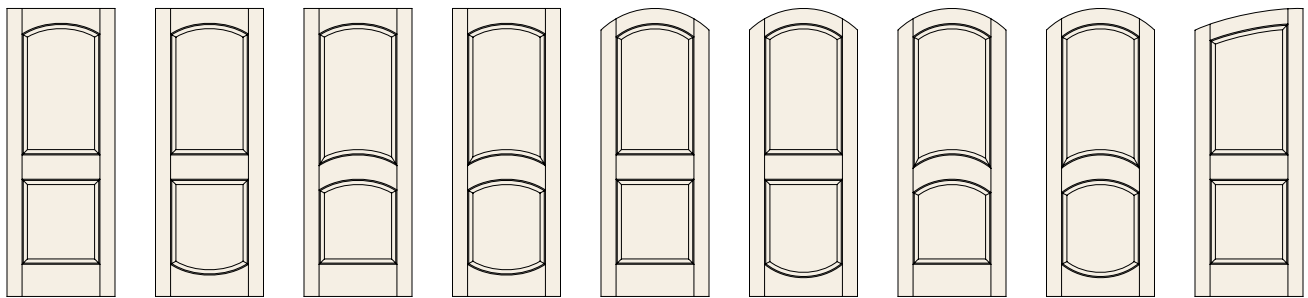

C22-A C22-AB C22-A10 C22-A10B C22-AA C22-AAB C22-AA10 C22-AA10B C22-S

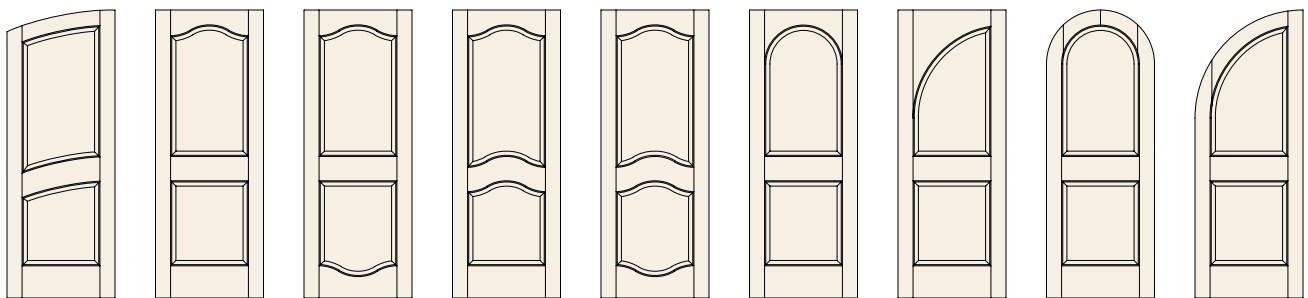

C22-S10 C22-CL C22-CLB C22-CL15 C22-CL15B C22-R C22-HR C22-RT C22-HRT

LE CHATEAU 2 PANELS

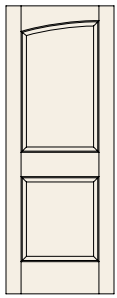

C22-HA

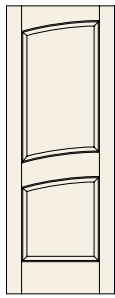

C22-HA10

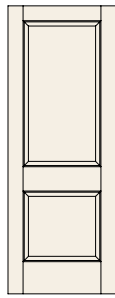

C24

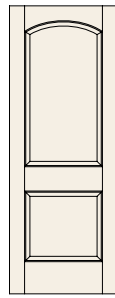

C24-A

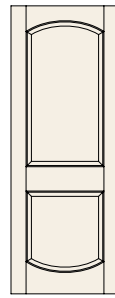

C24-AB

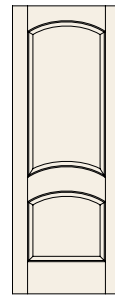

C24-A10

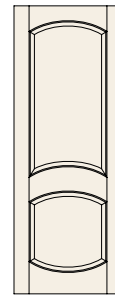

C24-A10B

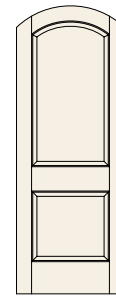

C24-AA

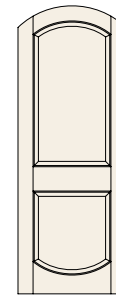

C24-AAB

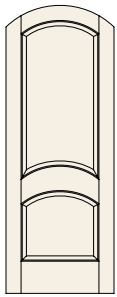

C24-AA10

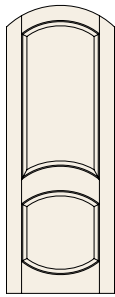

C24-AA10B

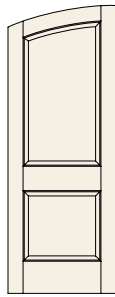

C24-S

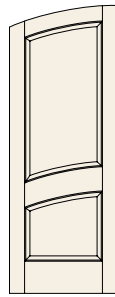

C24-S10

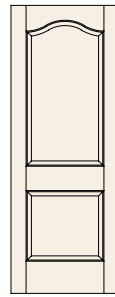

C24-CL

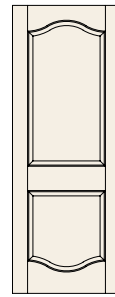

C24-CLB

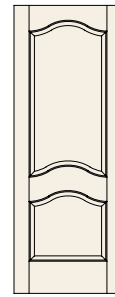

C24-CL15

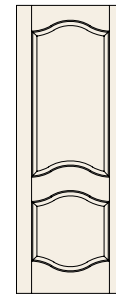

C24-CL15B

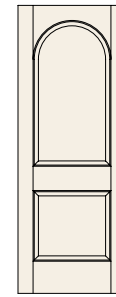

C24-R

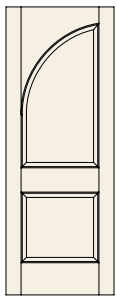

C24-HR

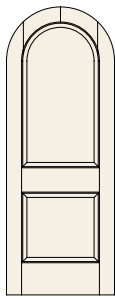

C24-RT

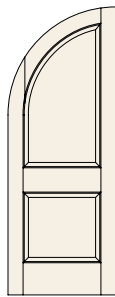

C24-HRT

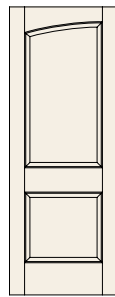

C24-HA

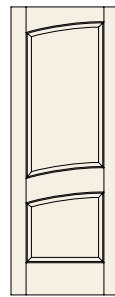

C24-HA10

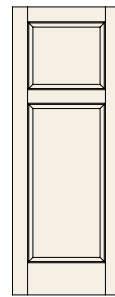

C25

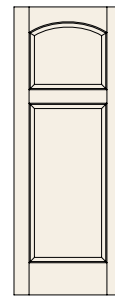

C25-A

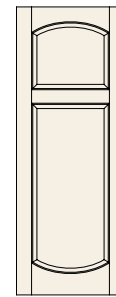

C25-AB

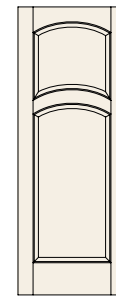

C25-A10

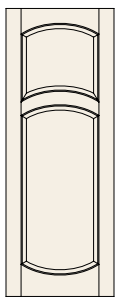

C25-A10B

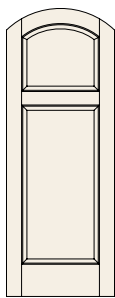

C25-AA

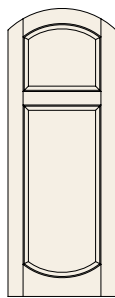

C25-AAB

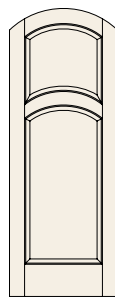

C25-AA10

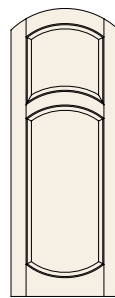

C25-AA10B

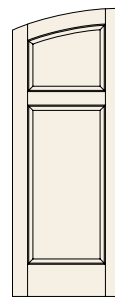

C25-S

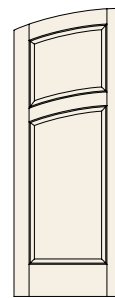

C25-S10

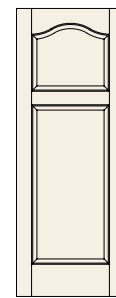

C25-CL

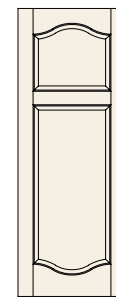

C25-CLB

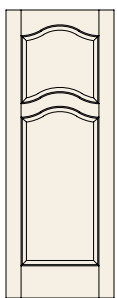

C25-CL15

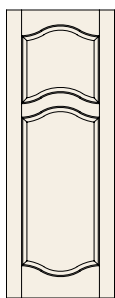

C25-CL15B

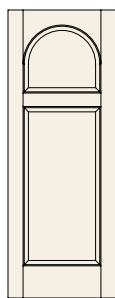

C25-R

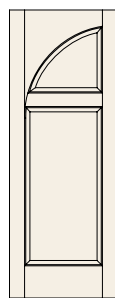

C25-HR

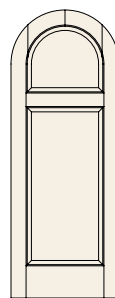

C25-RT

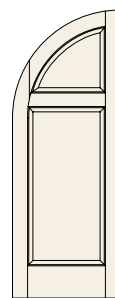

C25-HRT

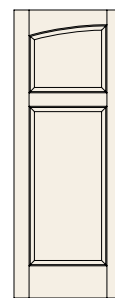

C25-HA

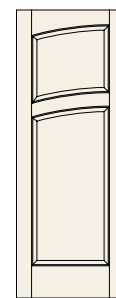

C25-HA10

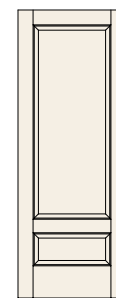

C26

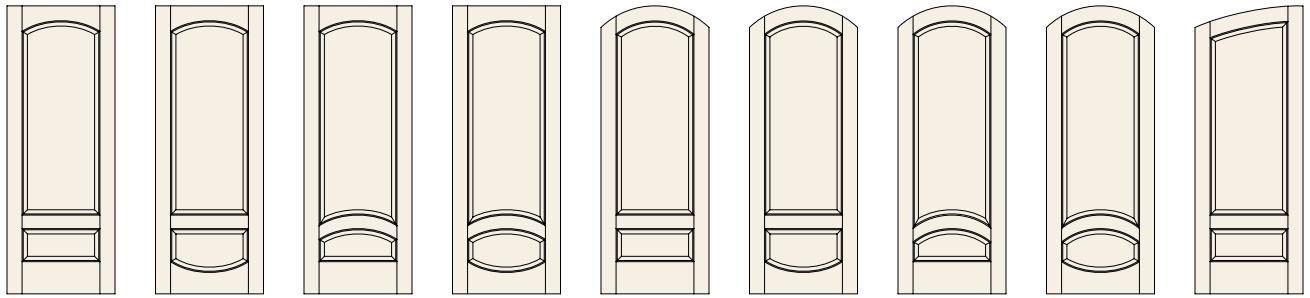

C26-A C26-AB C26-A10 C26-A10B C26-AA C26-AAB C26-AA10 C26-AA10B C26-S

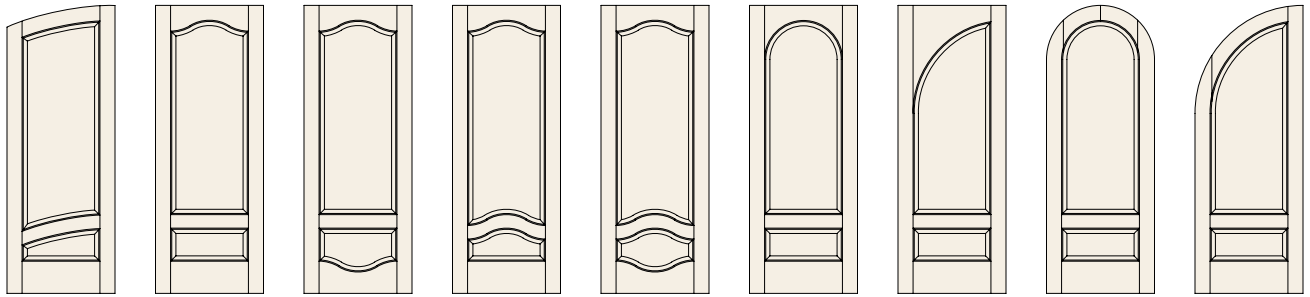

C26-S10 C26-CL C26-CLB C26-CL15 C26-CL15B C26-R C26-HR C26-RT C26-HRT

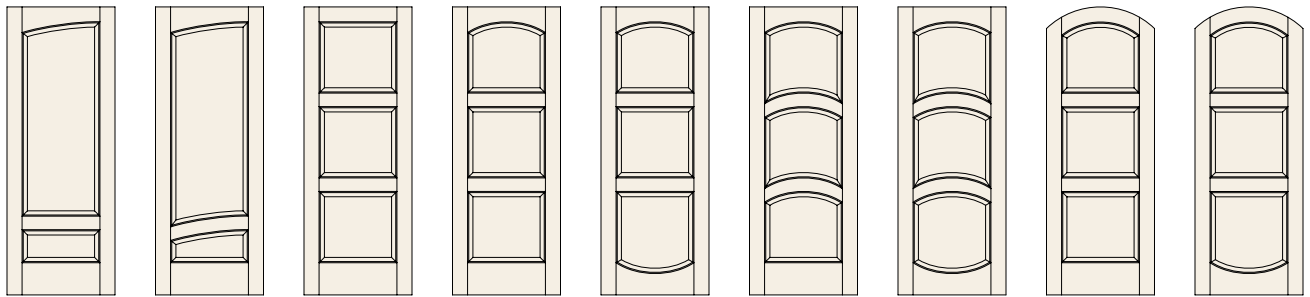

C26-HA C26-HA10 C30 C30-A C30-AB C30-A20 C30-A20B C30-AA C30-AAB

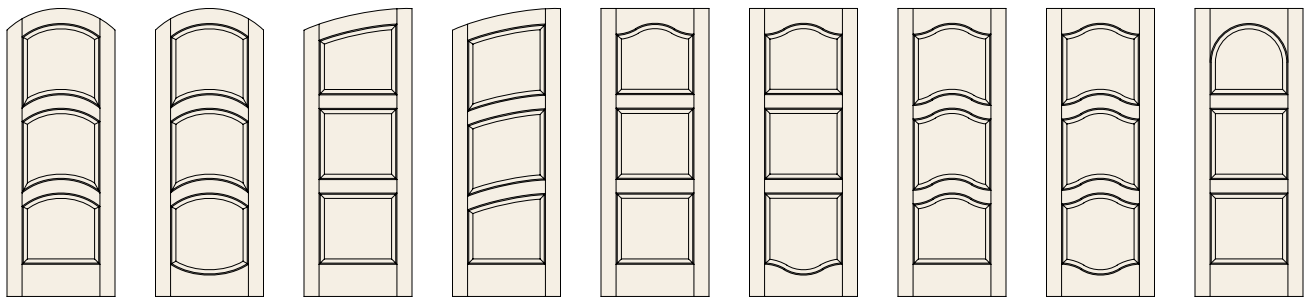

C30-AA20 C30-AA20B C30-S C30-S20 C30-CL C30-CLB C30-CL25 C30-CL25B C30-R

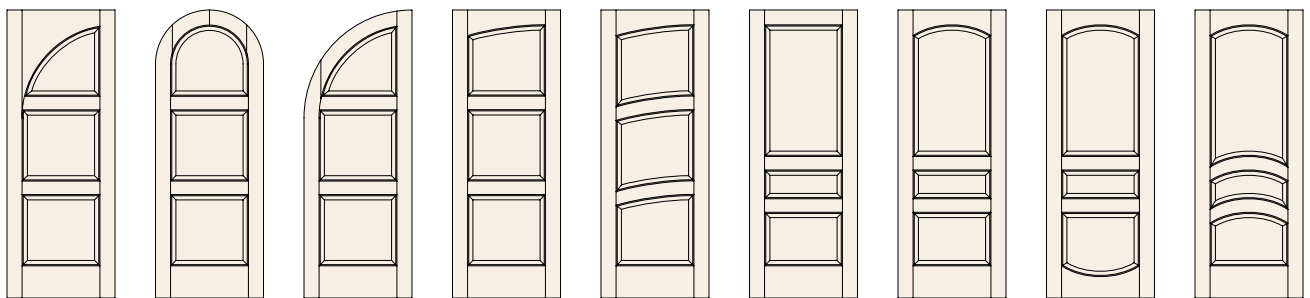

C30-HR C30-RT C30-HRT C30-HA C30-HA20 C31 C31-A C31-AB C31-A20

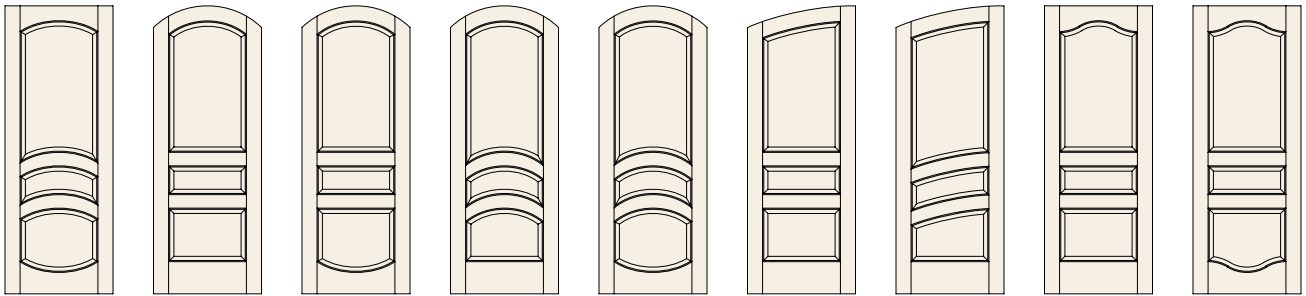

C31-A20B C31-AA C31-AAB C31-AA20 C31-AA20B C31-S C31-S20 C31-CL C31-CLB

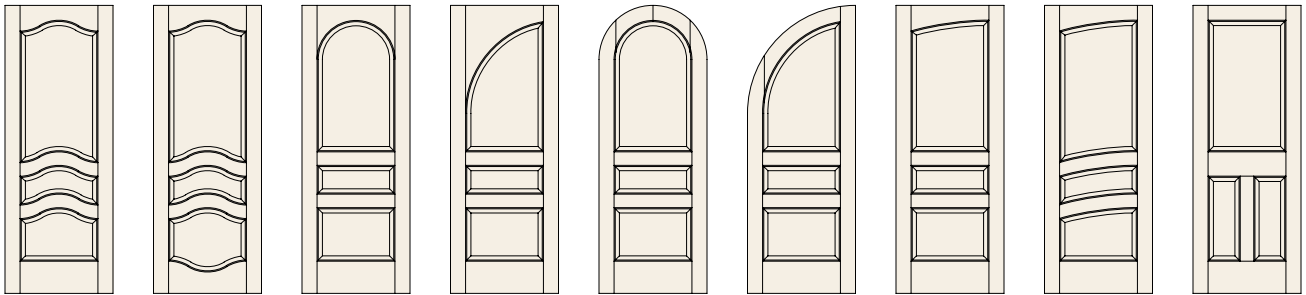

C31-CL25 C31-CL25B C31-R C31-HR C31-RT C31-HRT C31-HA C31-HA20 C32

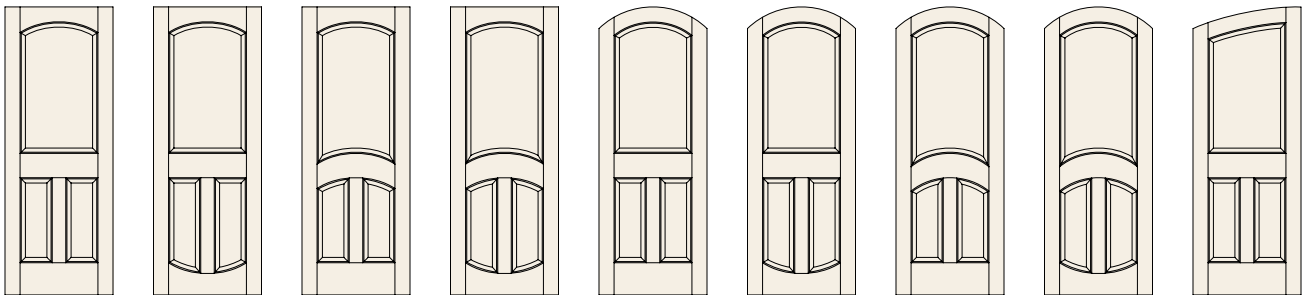

C32-A C32-AB C32-A10 C32-A10B C32-AA C32-AAB C32-AA10 C32-AA10B C32-S

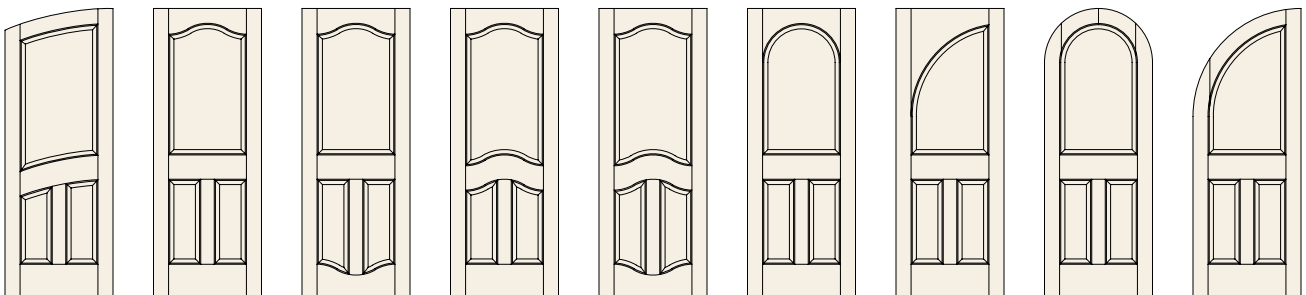

C32-S10 C32-CL C32-CLB C32-CL15 C32-CL15B C32-R C32-HR C32-RT C32-HRT

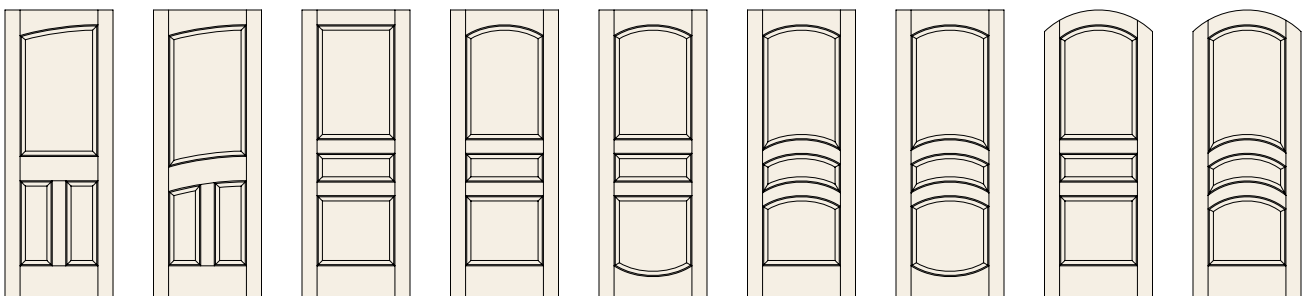

C32-HA C32-HA10 C33 C33-A C33-AB C33-A20 C33-A20B C33-AA C33-AA20

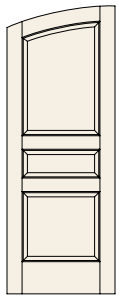

C33-S

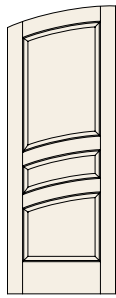

C33-S20

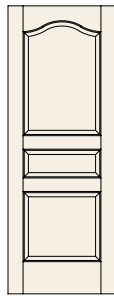

C33-CL

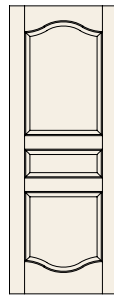

C33-CLB

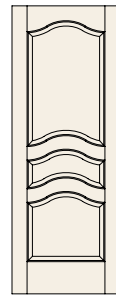

C33-CL25

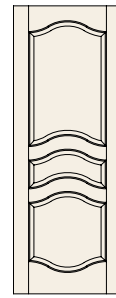

C33-CL25B

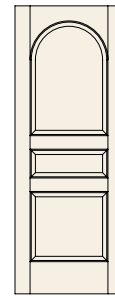

C33-R

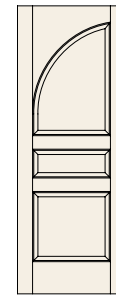

C33-HR

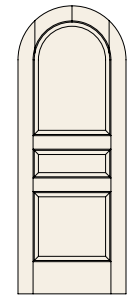

C33-RT

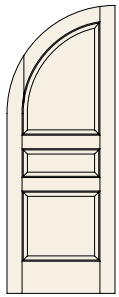

C33-HRT

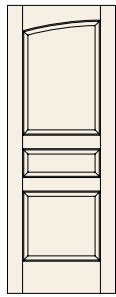

C33-HA

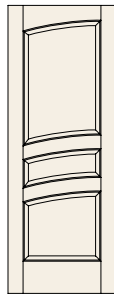

C33-HA20

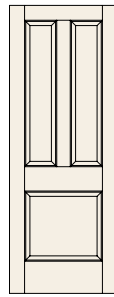

C34

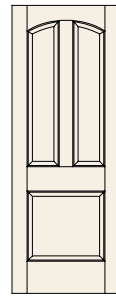

C34-A

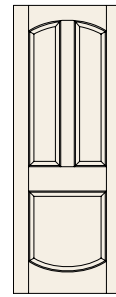

C34-AB

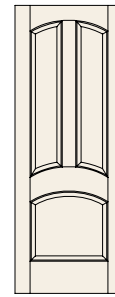

C34-A10

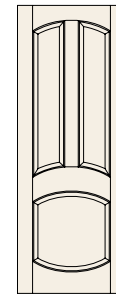

C34-A10B

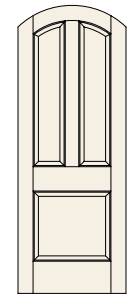

C34-AA

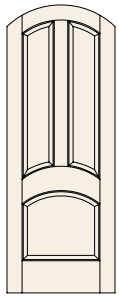

C34-AA10

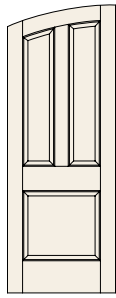

C34-S

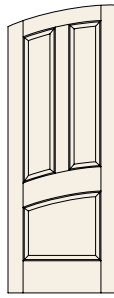

C34-S10

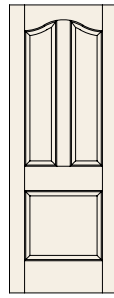

C34-CL

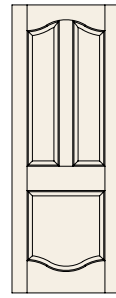

C34-CLB

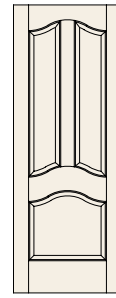

C34-CL15

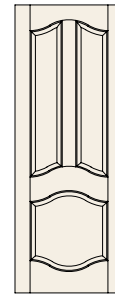

C34-CL15B

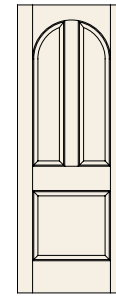

C34-R

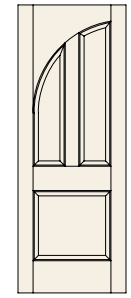

C34-HR

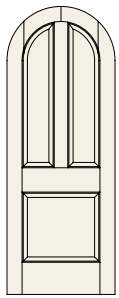

C34-RT

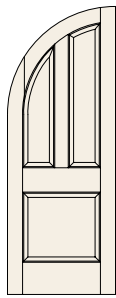

C34-HRT

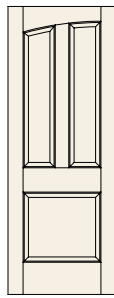

C34-HA

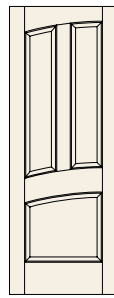

C34-HA10

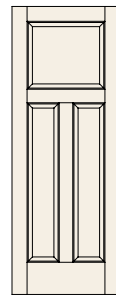

C35

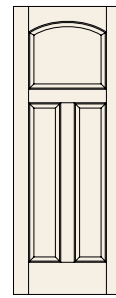

C35-A

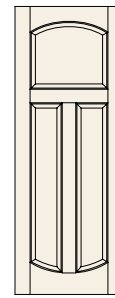

C35-AB

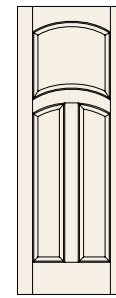

C35-A10

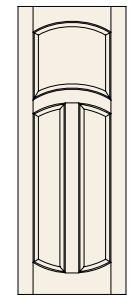

C35-A10B

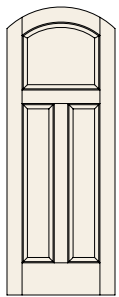

C35-AA

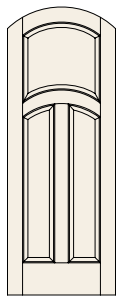

C35-AA10

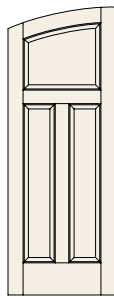

C35-S

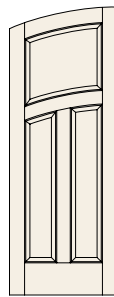

C35-S10

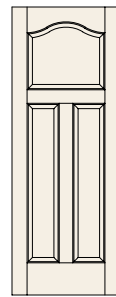

C35-CL

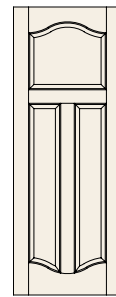

C35-CLB

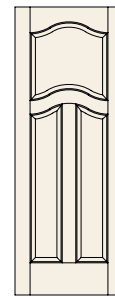

C35-CL15

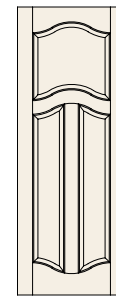

C35-CL15B

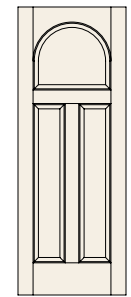

C35-R

LE CHATEAU 3 PANELS

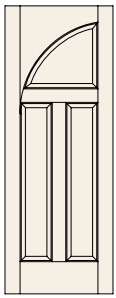

C35-HR

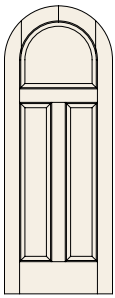

C35-RT

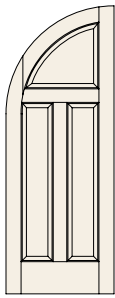

C35-HRT

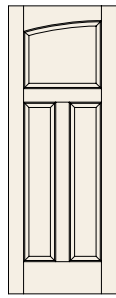

C35-HA

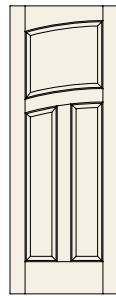

C35-HA10

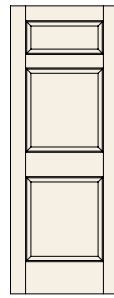

C36

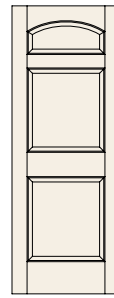

C36-A

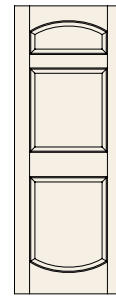

C36-AB

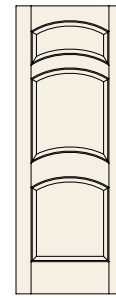

C36-A20

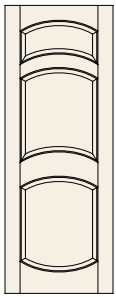

C36-A20B

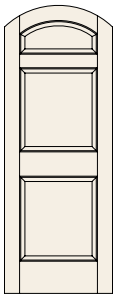

C36-AA

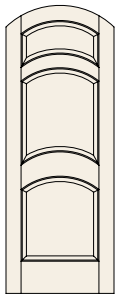

C36-AA20

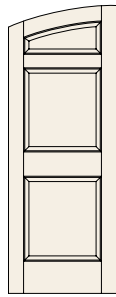

C36-S

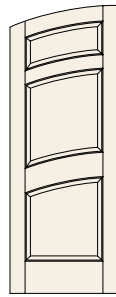

C36-S20

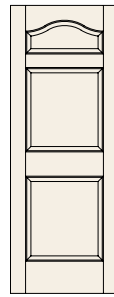

C36-CL

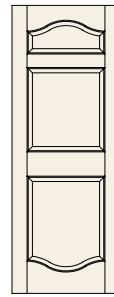

C36-CLB

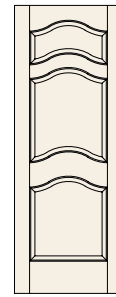

C36-CL25

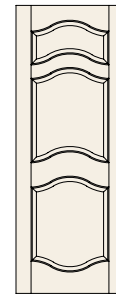

C36-CL25B

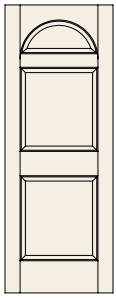

C36-R

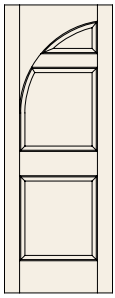

C36-HR

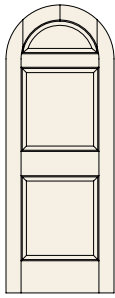

C36-RT

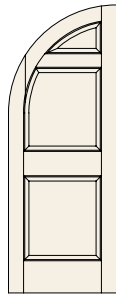

C36-HRT

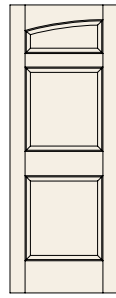

C36-HA

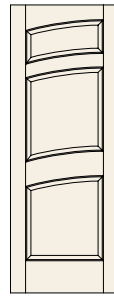

C36-HA20

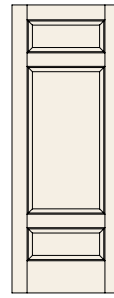

C37

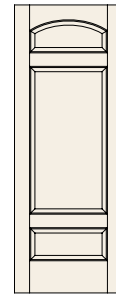

C37-A

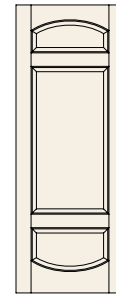

C37-AB

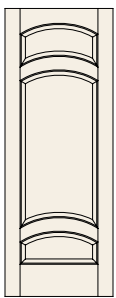

C37-A20

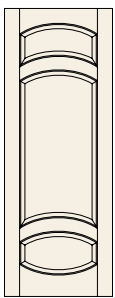

C37-A20B

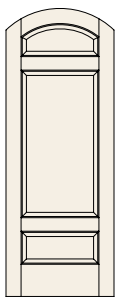

C37-AA

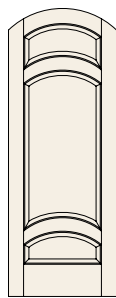

C37-AA20

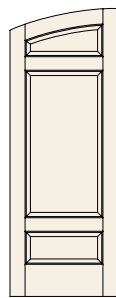

C37-S

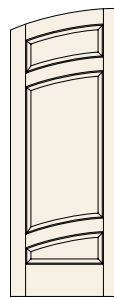

C37-S20

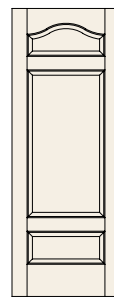

C37-CL

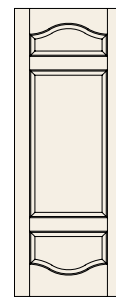

C37-CLB

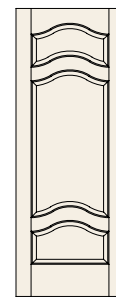

C37-CL25

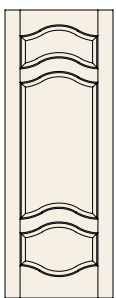

C37-CL25B

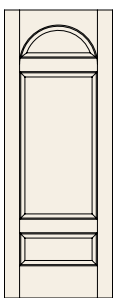

C37-R

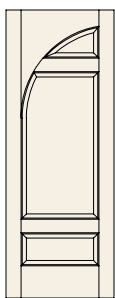

C37-HR

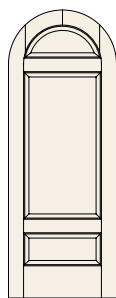

C37-RT

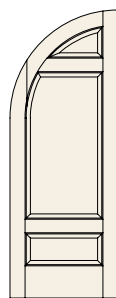

C37-HRT

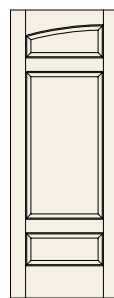

C37-HA

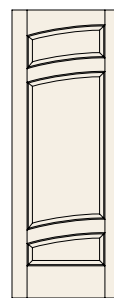

C37-HA20

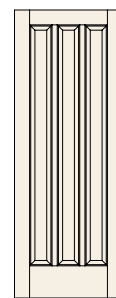

C38

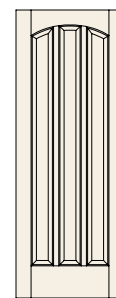

C38-A

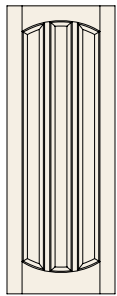

C38-AB

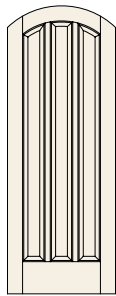

C38-AA

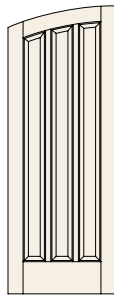

C38-S

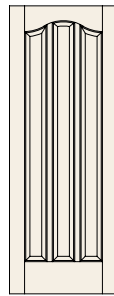

C38-CL

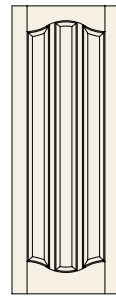

C38-CLB

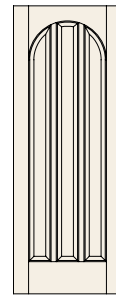

C38-R

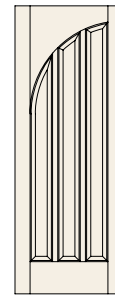

C38-HR

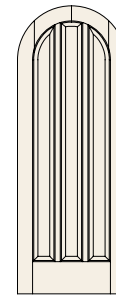

C38-RT

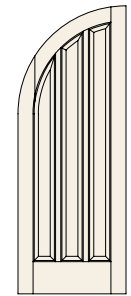

C38-HRT

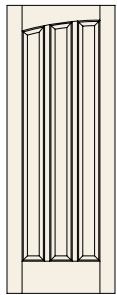

C38-HA

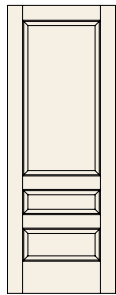

C39

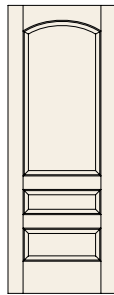

C39-A

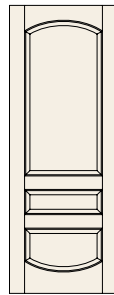

C39-AB

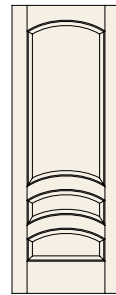

C39-A20

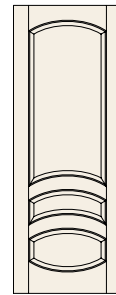

C39-A20B

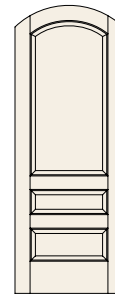

C39-AA

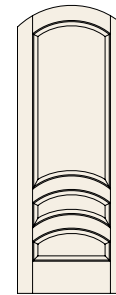

C39-AA20

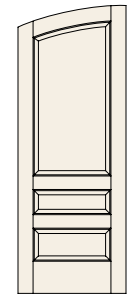

C39-S

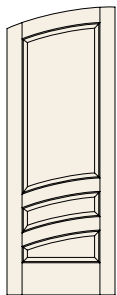

C39-S20

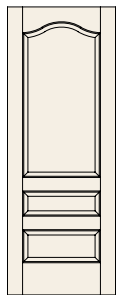

C39-CL

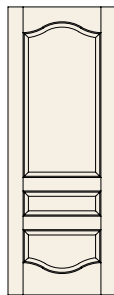

C39-CLB

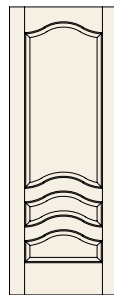

C39-CL25

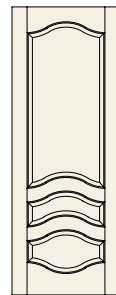

C39-CL25B

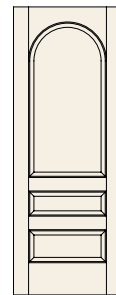

C39-R

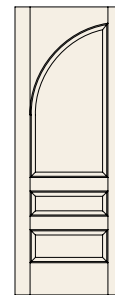

C39-HR

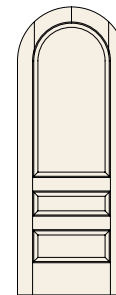

C39-RT

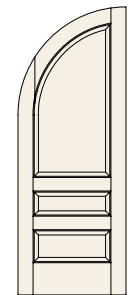

C39-HRT

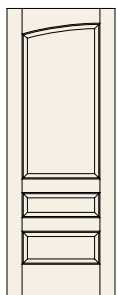

C39-HA

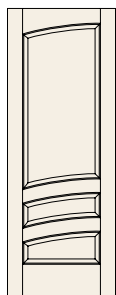

C39-HA20

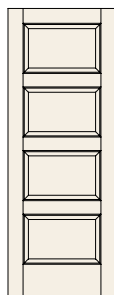

C40

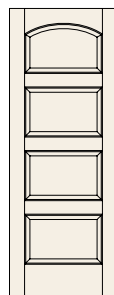

C40-A

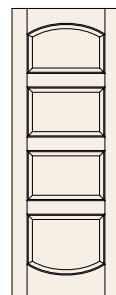

C40-AB

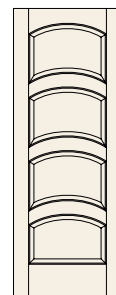

C40-A30

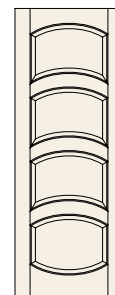

C40-A30B

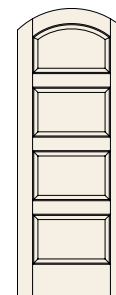

C40-AA

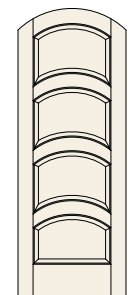

C40-AA30

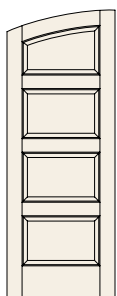

C40-S

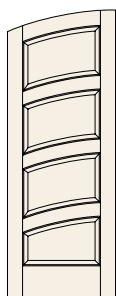

C40-S30

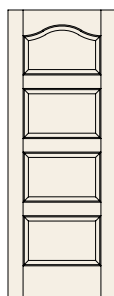

C40-CL

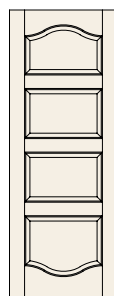

C40-CLB

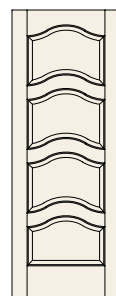

C40-CL35

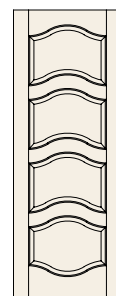

C40-CL35B

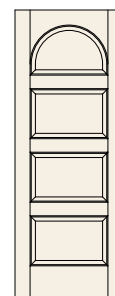

C40-R

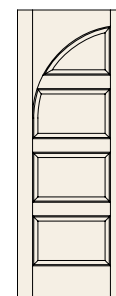

C40-HR

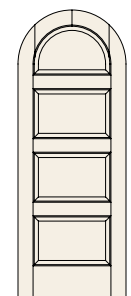

C40-RT

LE CHATEAU 4 PANELS

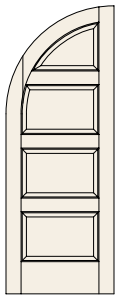

C40-HRT

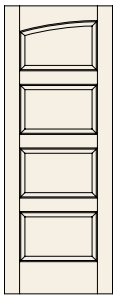

C40-HA

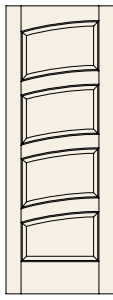

C40-HA30

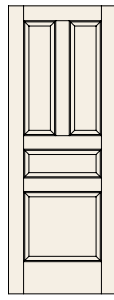

C41

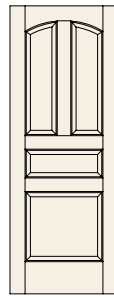

C41-A

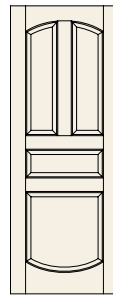

C41-AB

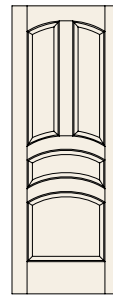

C41-A20

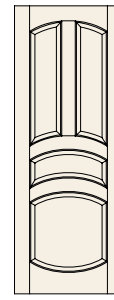

C41-A20B

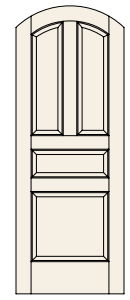

C41-AA

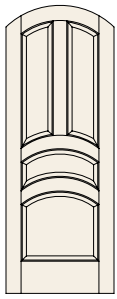

C41-AA20

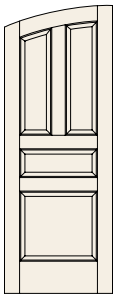

C41-S

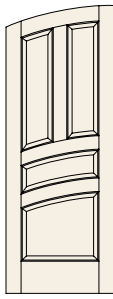

C41-S20

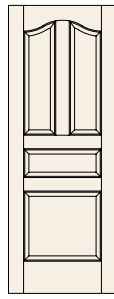

C41-CL

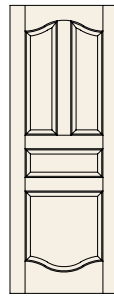

C41-CLB

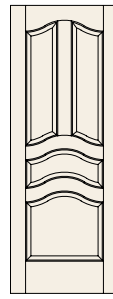

C41-CL25

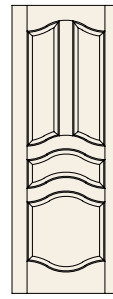

C41-CL25B

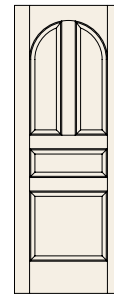

C41-R

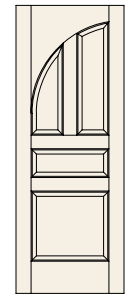

C41-HR

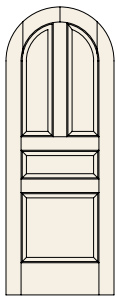

C41-RT

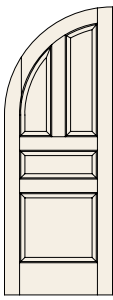

C41-HRT

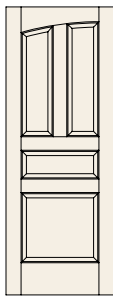

C41-HA

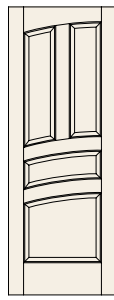

C41-HA20

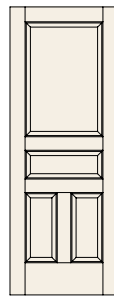

C411

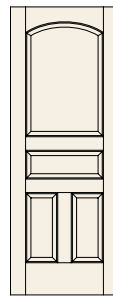

C411-A

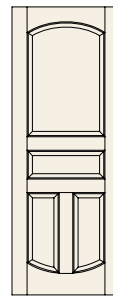

C411-AB

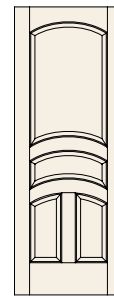

C411-A20

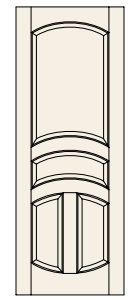

C411-A20B

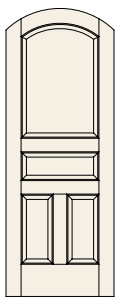

C411-AA

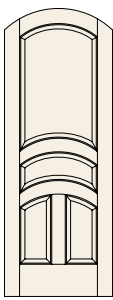

C411-AA20

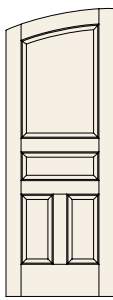

C411-S

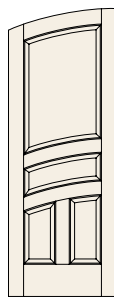

C411-S20

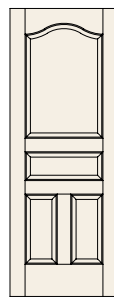

C411-CL

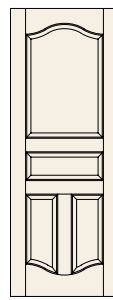

C411-CLB

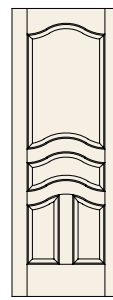

C411-CL25

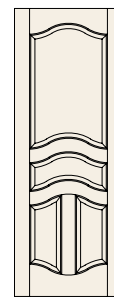

C411-CL25B

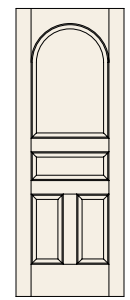

C411-R

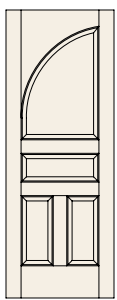

C411-HR

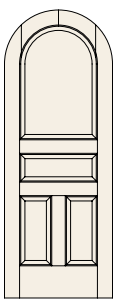

C411-RT

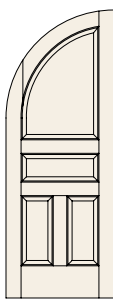

C411-HRT

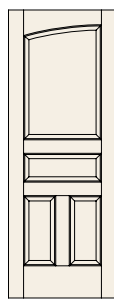

C411-HA

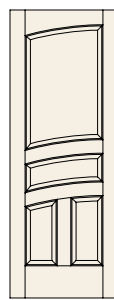

C411-HA20

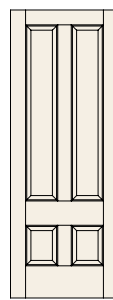

C42

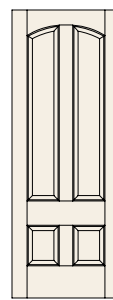

C42-A

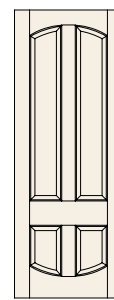

C42-AB

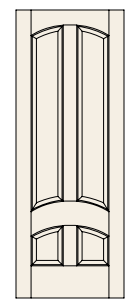

C42-A10

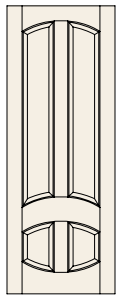

C42-A10B

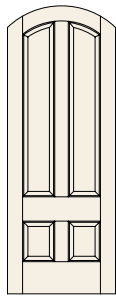

C42-AA

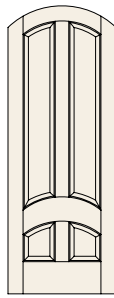

C42-AA10

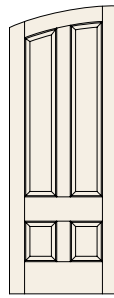

C42-S

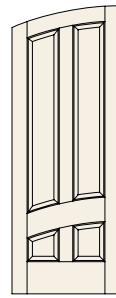

C42-S10

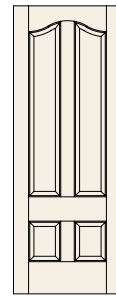

C42-CL

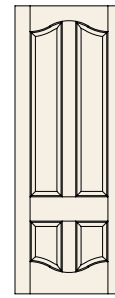

C42-CLB

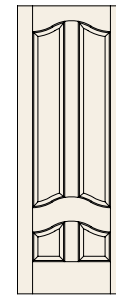

C42-CL15

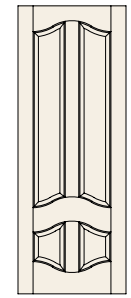

C42-CL15B

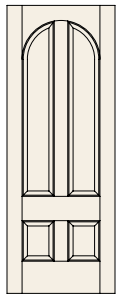

C42-R

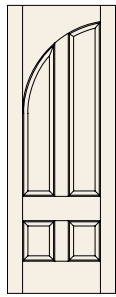

C42-HR

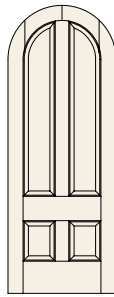

C42-RT

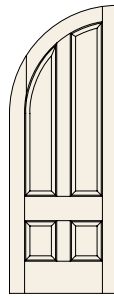

C42-HRT

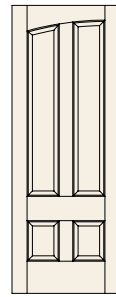

C42-HA

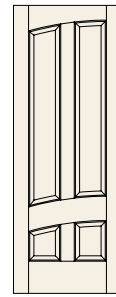

C42-HA10

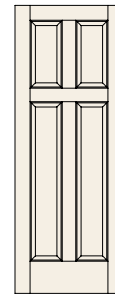

C422

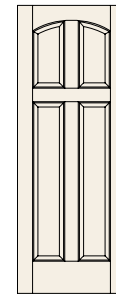

C422-A

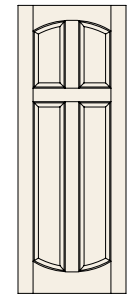

C422-AB

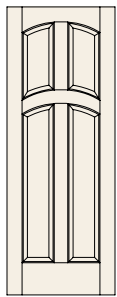

C422-A10

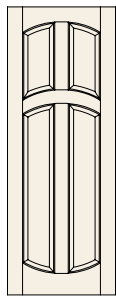

C422-A10B

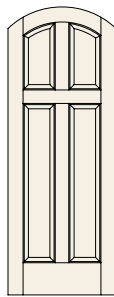

C422-AA

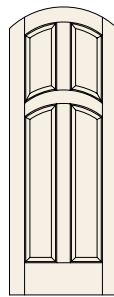

C422-AA10

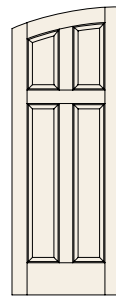

C422-S

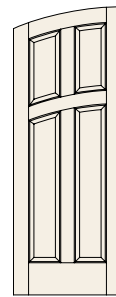

C422-S10

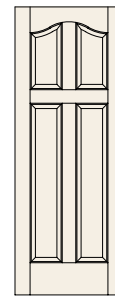

C422-CL

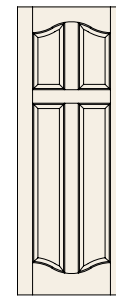

C422-CLB

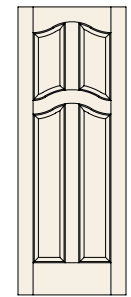

C422-CL15

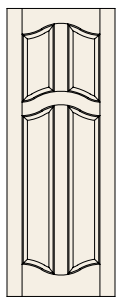

C422-CL15B

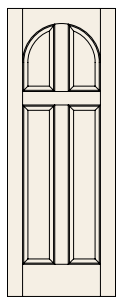

C422-R

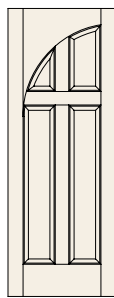

C422-HR

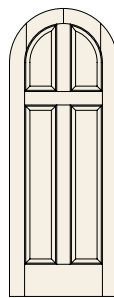

C422-RT

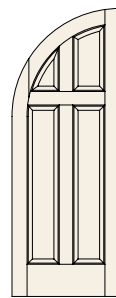

C422-HRT

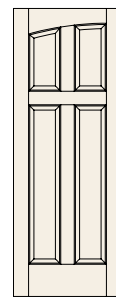

C422-HA

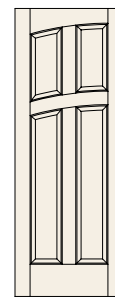

C422-HA10

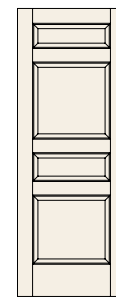

C43

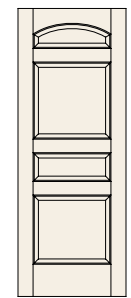

C43-A

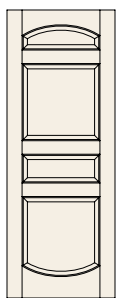

C43-AB

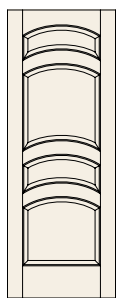

C43-A30

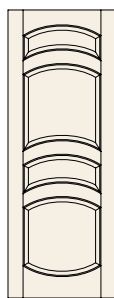

C43-A30B

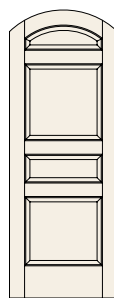

C43-AA

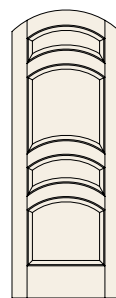

C43-AA30

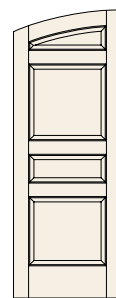

C43-S

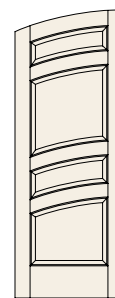

C43-S30

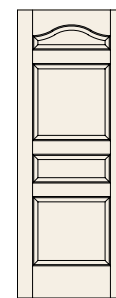

C43-CL

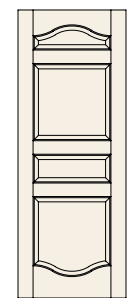

C43-CLB

LE CHATEAU 4 PANELS

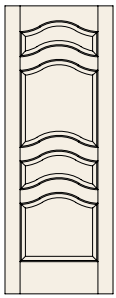

C43-CL35

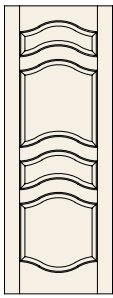

C43-CL35B

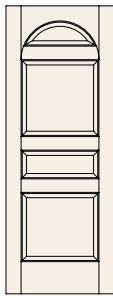

C43-R

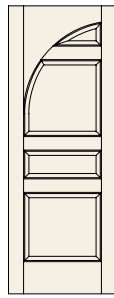

C43-HR

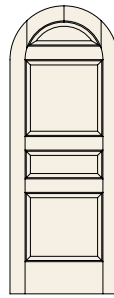

C43-RT

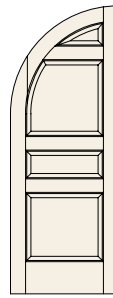

C43-HRT

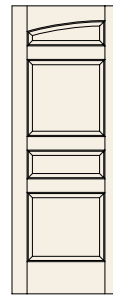

C43-HA

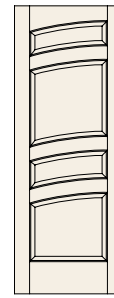

C43-HA30

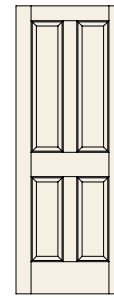

C44

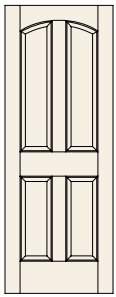

C44-A

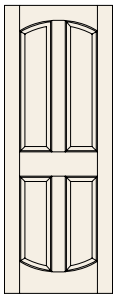

C44-AB

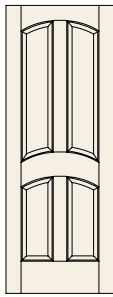

C44-A10

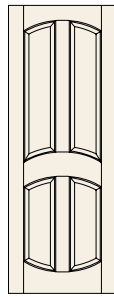

C44-A10B

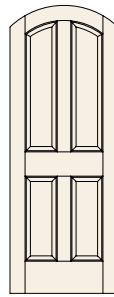

C44-AA

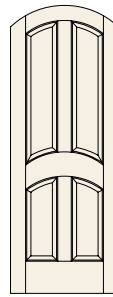

C44-AA10

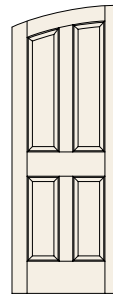

C44-S

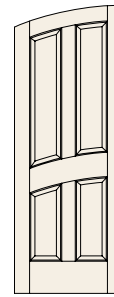

C44-S10

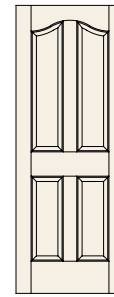

C44-CL

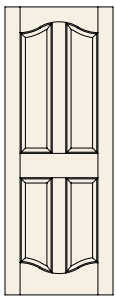

C44-CLB

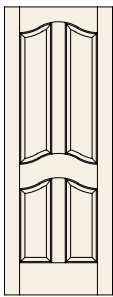

C44-CL15

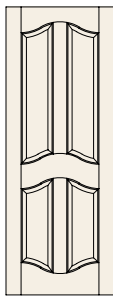

C44-CL15B

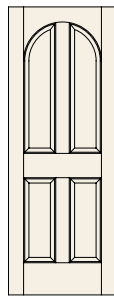

C44-R

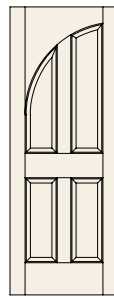

C44-HR

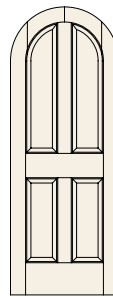

C44-RT

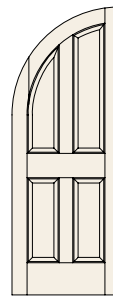

C44-HRT

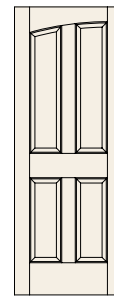

C44-HA

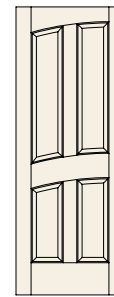

C44-HA10

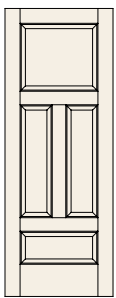

C45

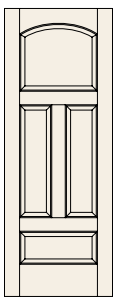

C45-A

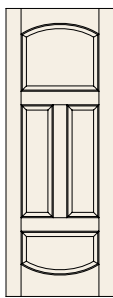

C45-AB

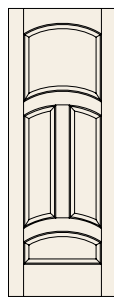

C45-A20

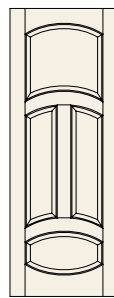

C45-A20B

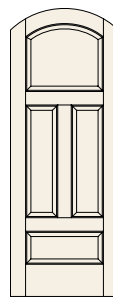

C45-AA

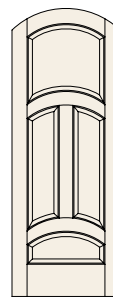

C45-AA20

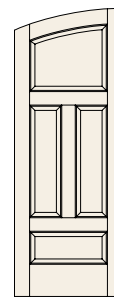

C45-S

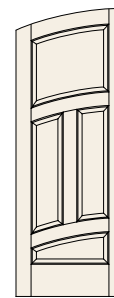

C45-S20

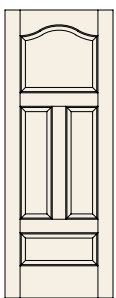

C45-CL

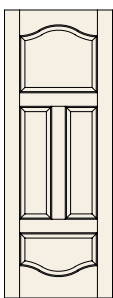

C45-CLB

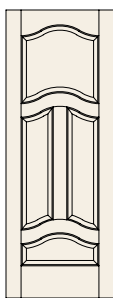

C45-CL25

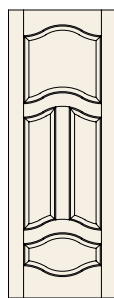

C45-CL25B

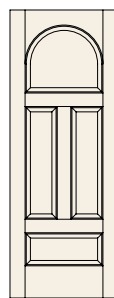

C45-R

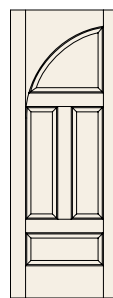

C45-HR

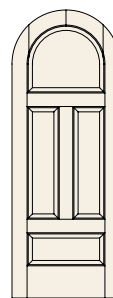

C45-RT

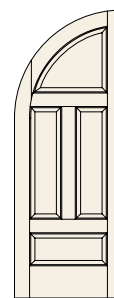

C45-HRT

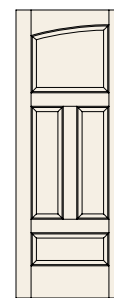

C45-HA

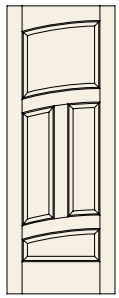

C45-HA20

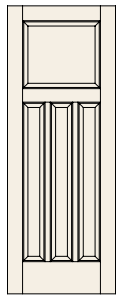

C46

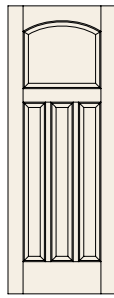

C46-A

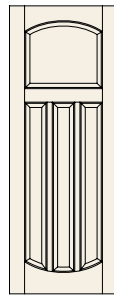

C46-AB

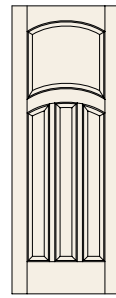

C46-A10

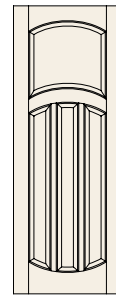

C46-A10B

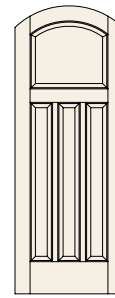

C46-AA

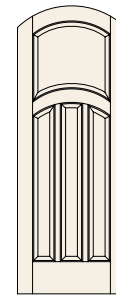

C46-AA10

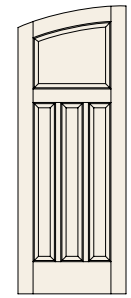

C46-S

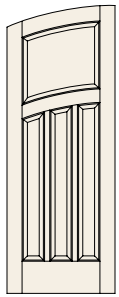

C46-S10

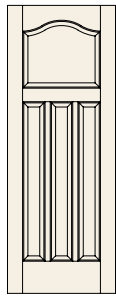

C46-CL

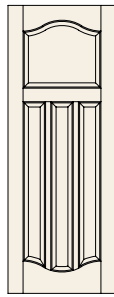

C46-CLB

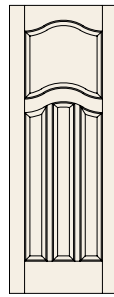

C46-CL15

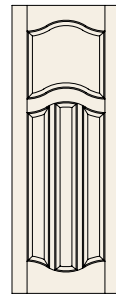

C46-CL15B

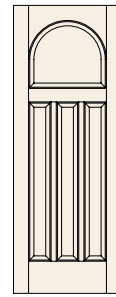

C46-R

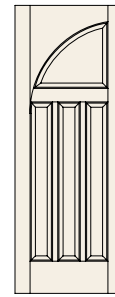

C46-HR

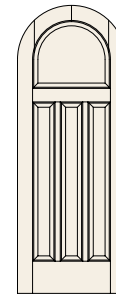

C46-RT

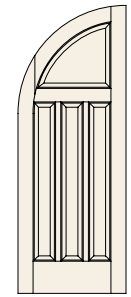

C46-HRT

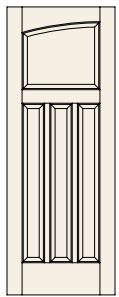

C46-HA

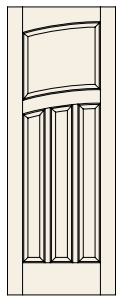

C46-HA10

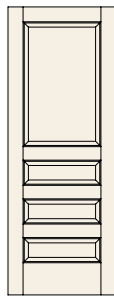

C47

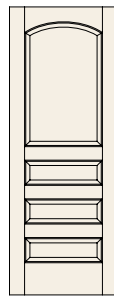

C47-A

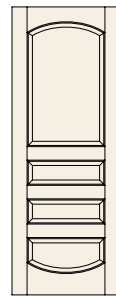

C47-AB

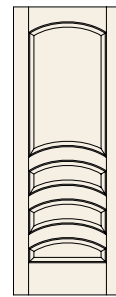

C47-A30

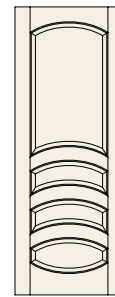

C47-A30B

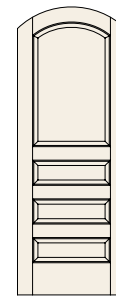

C47-AA

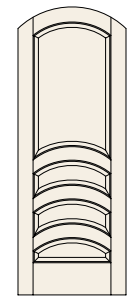

C47-AA30

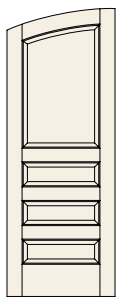

C47-S

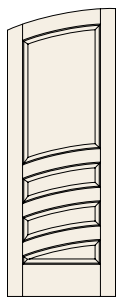

C47-S30

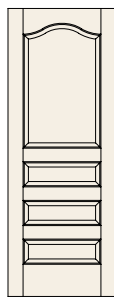

C47-CL

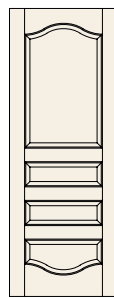

C47-CLB

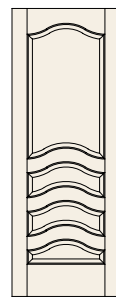

C47-CL35

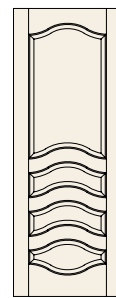

C47-CL35B

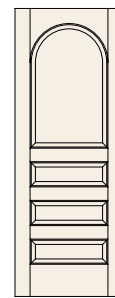

C47-R

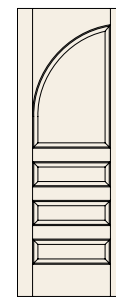

C47-HR

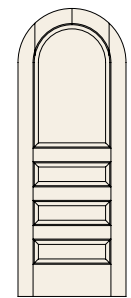

C47-RT

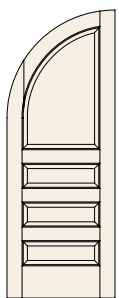

C47-HRT

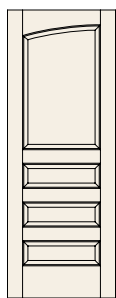

C47-HA

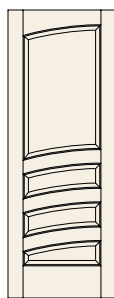

C47-HA30

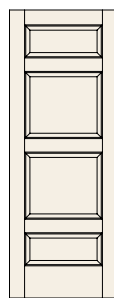

C48

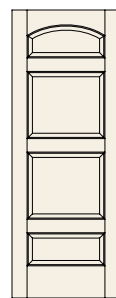

C48-A

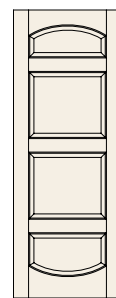

C48-AB

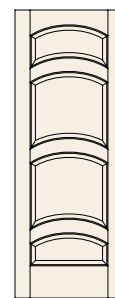

C48-A30

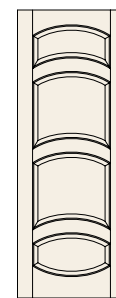

C48-A30B

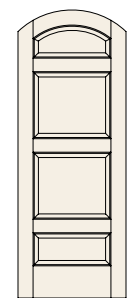

C48-AA

LE CHATEAU 4 & 5 PANELS

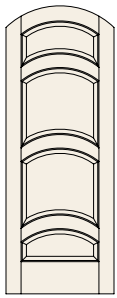

C48-AA30

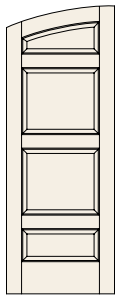

C48-S

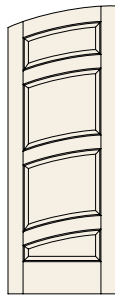

C48-S30

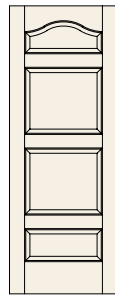

C48-CL

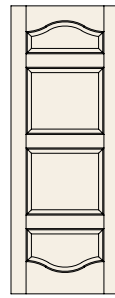

C48-CLB

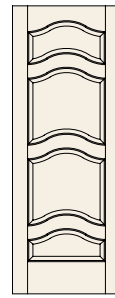

C48-CL35

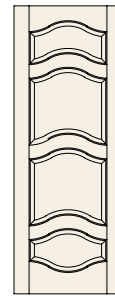

C48-CL35B

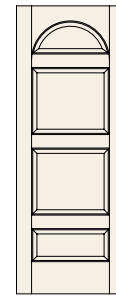

C48-R

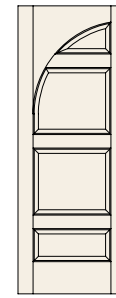

C48-HR

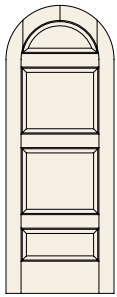

C48-RT

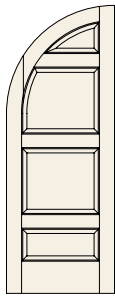

C48-HRT

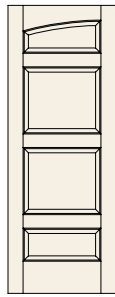

C48-HA

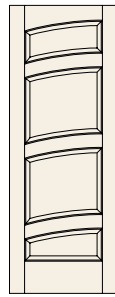

C48-HA30

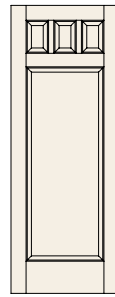

C49

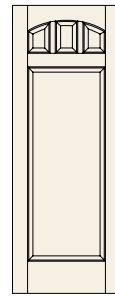

C49-A

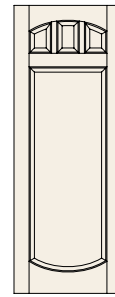

C49-AB

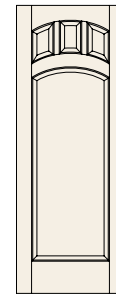

C49-A10

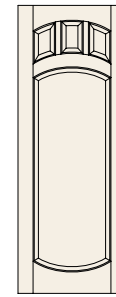

C49-A10B

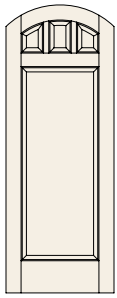

C49-AA

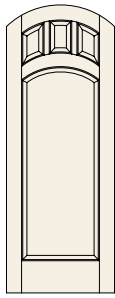

C49-AA10

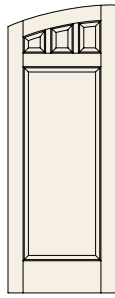

C49-S

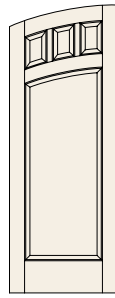

C49-S10

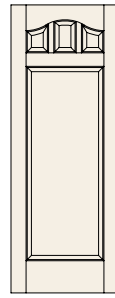

C49-CL

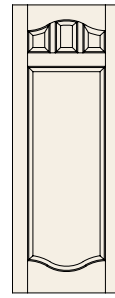

C49-CLB

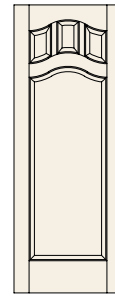

C49-CL15

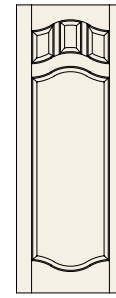

C49-CL15B

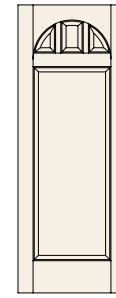

C49-R

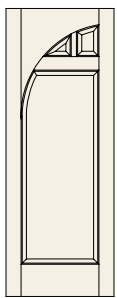

C49-HR

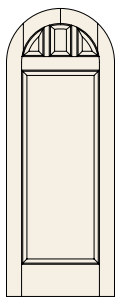

C49-RT

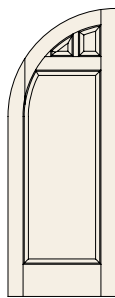

C49-HRT

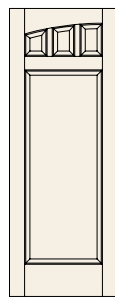

C49-HA

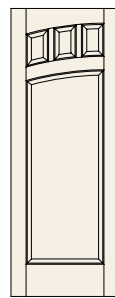

C49-HA10

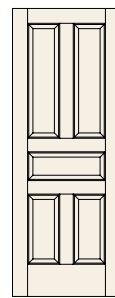

C51

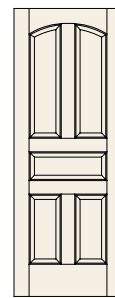

C51-A

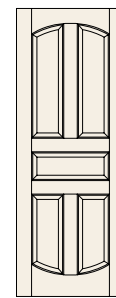

C51-AB

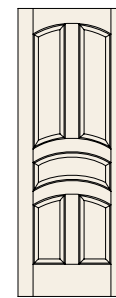

C51-A20

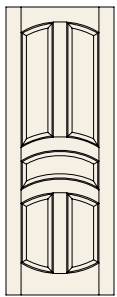

C51-A20B

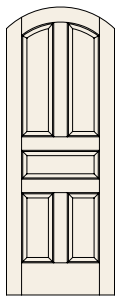

C51-AA

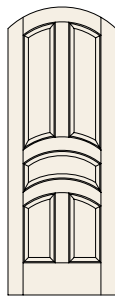

C51-AA20

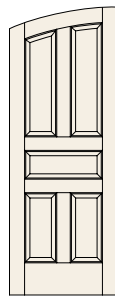

C51-S

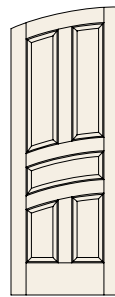

C51-S20

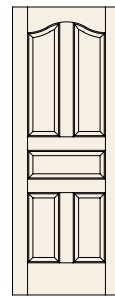

C51-CL

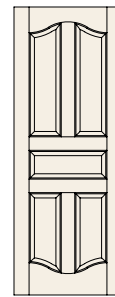

C51-CLB

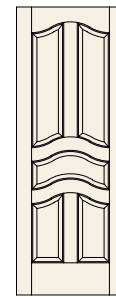

C51-CL25

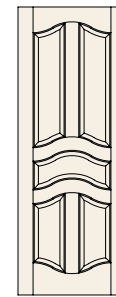

C51-CL25B

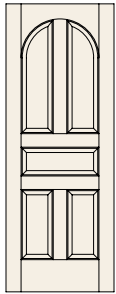

C51-R

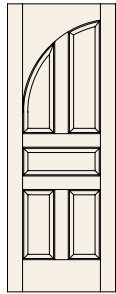

C51-HR

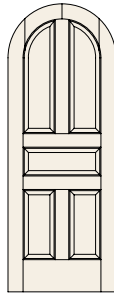

C51-RT

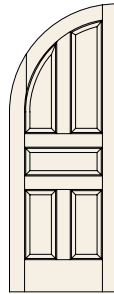

C51-HRT

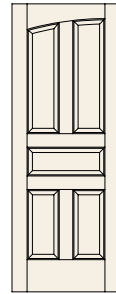

C51-HA

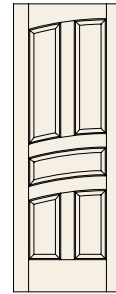

C51-HA20



C52

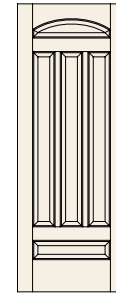

C52-A



C52-AB

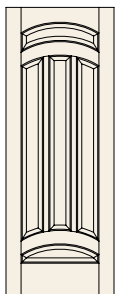

C52-A20

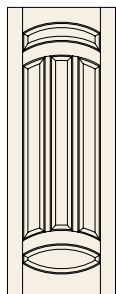

C52-A20B

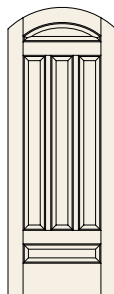

C52-AA

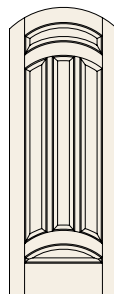

C52-AA20

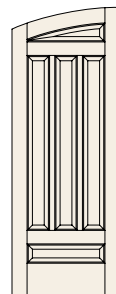

C52-S

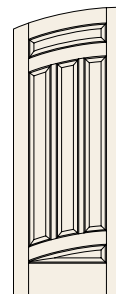

C52-S20

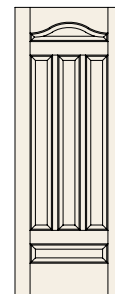

C52-CL

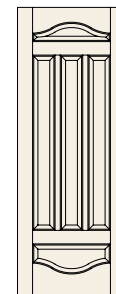

C52-CLB



C52-R

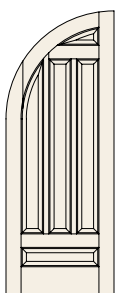

C52-HR

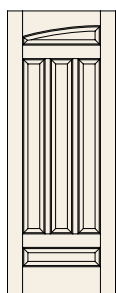

C52-HA

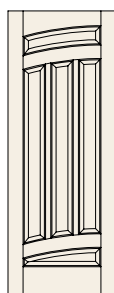

C52-HA20

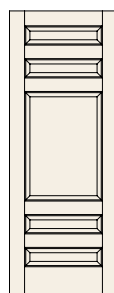

C53

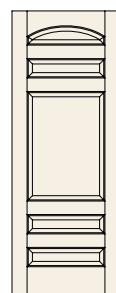

C53-A

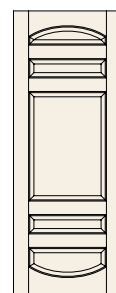

C53-AB

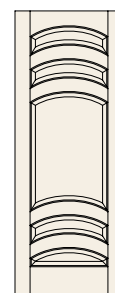

C53-A40

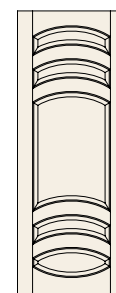

C53-A40B

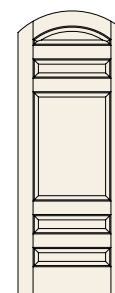

C53-AA

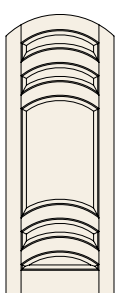

C53-AA40

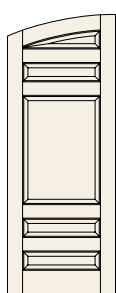

C53-S

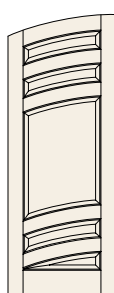

C53-S40

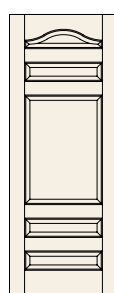

C53-CL

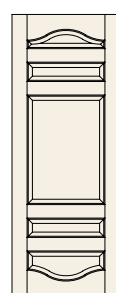

C53-CLB

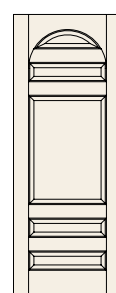

C53-R

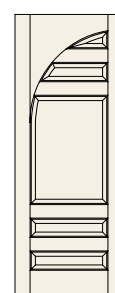

C53-HR

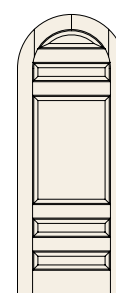

C53-RT

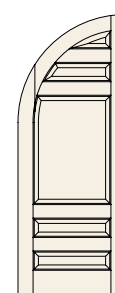

C53-HRT

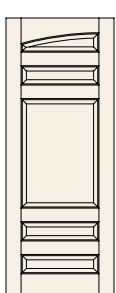

C53-HA

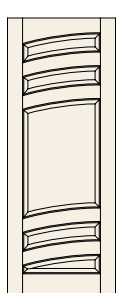

C53-HA40

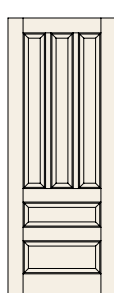

C54

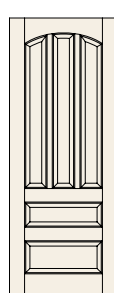

C54-A

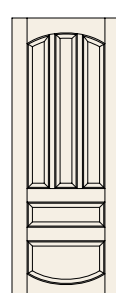

C54-AB

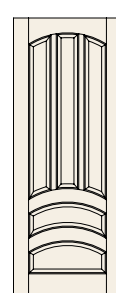

C54-A20

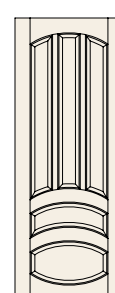

C54-A20B

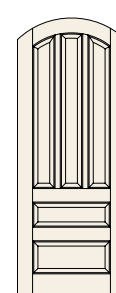

C54-AA

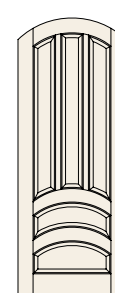

C54-AA20

LE CHATEAU 5 PANELS

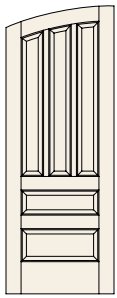

C54-S

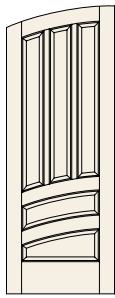

C54-S20

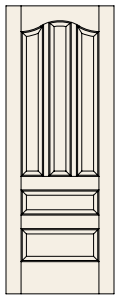

C54-CL

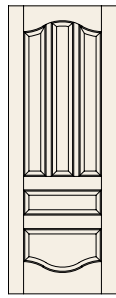

C54-CLB

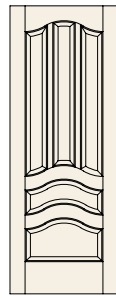

C54-CL25

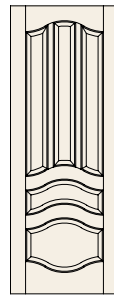

C54-CL25B

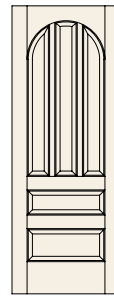

C54-R

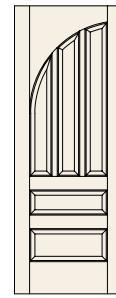

C54-HR

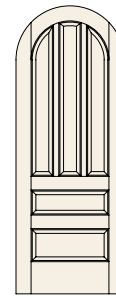

C54-RT

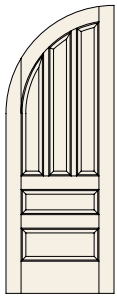

C54-HRT

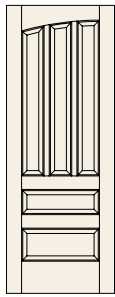

C54-HA

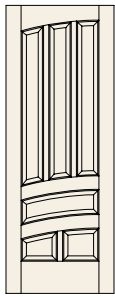

C54-HA20

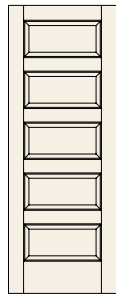

C55

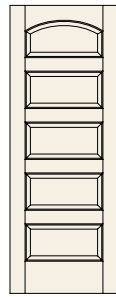

C55-A

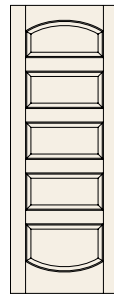

C55-AB

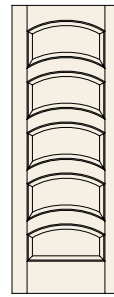

C55-A40

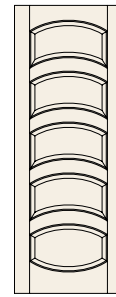

C55-A40B

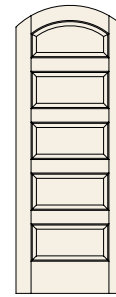

C55-AA

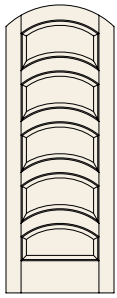

C55-AA40

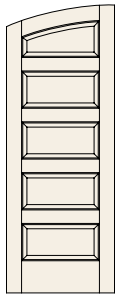

C55-S

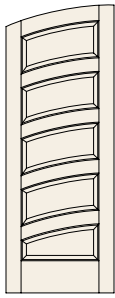

C55-S40

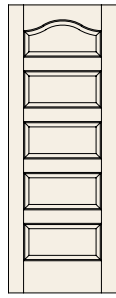

C55-CL



C55-CLB

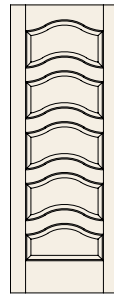

C55-CL45

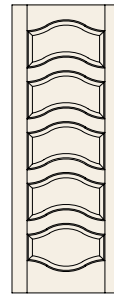

C55-CL45B

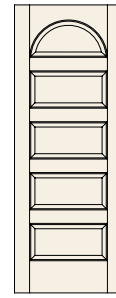

C55-R

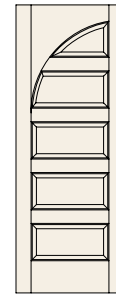

C55-HR

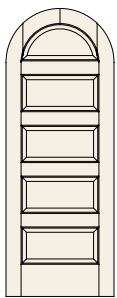

C55-RT

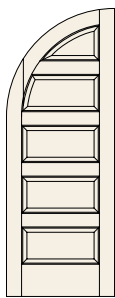

C55-HRT

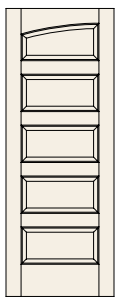

C55-HA

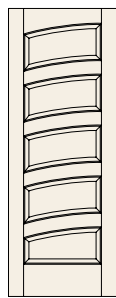

C55-HA40

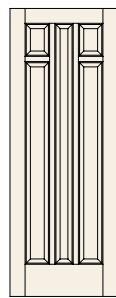

C56

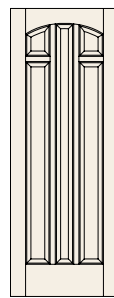

C56-A

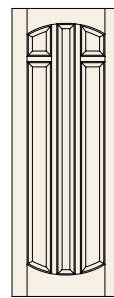

C56-AB

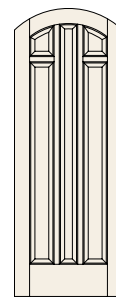

C56-AA

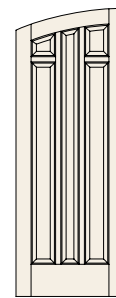

C56-S

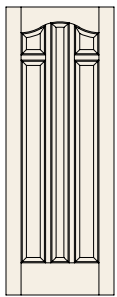

C56-CL

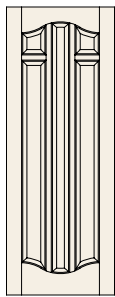

C56-CLB



C56-R

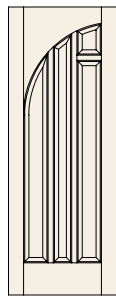

C56-HR

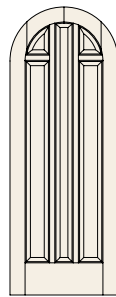

C56-RT

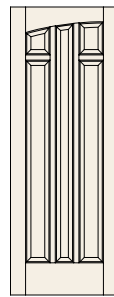

C56-HA

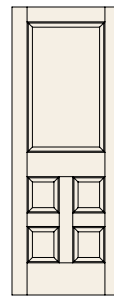

C57

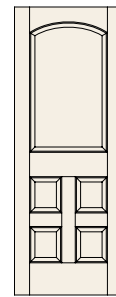

C57-A

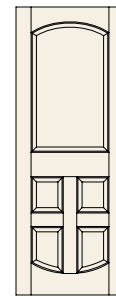

C57-AB

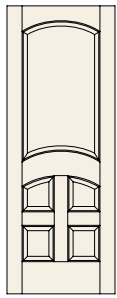

C57-A10

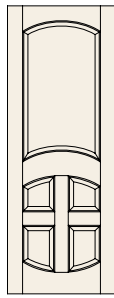

C57-A10B

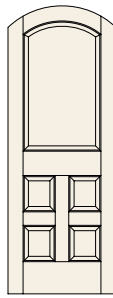

C57-AA

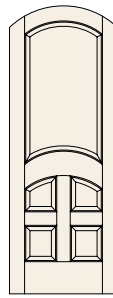

C57-AA10

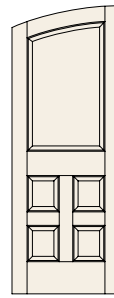

C57-S

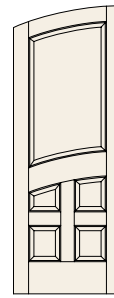

C57-S10

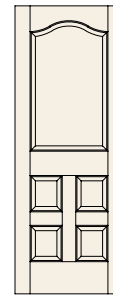

C57-CL

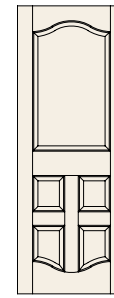

C57-CLB

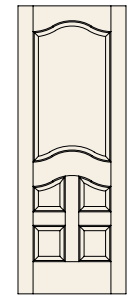

C57-CL15

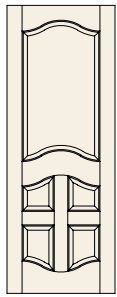

C57-CL15B

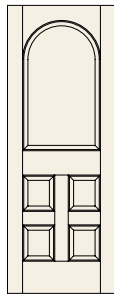

C57-R

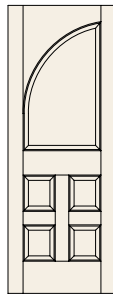

C57-HR

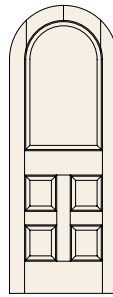

C57-RT

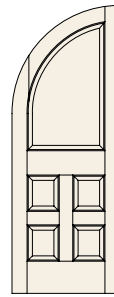

C57-HRT

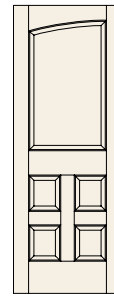

C57-HA

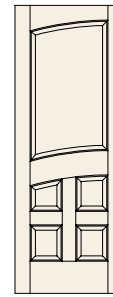

C57-HA10

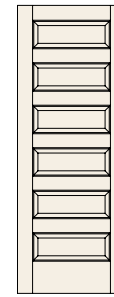

C60

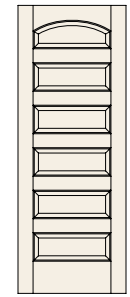

C60-A

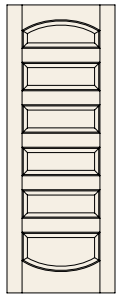

C60-AB

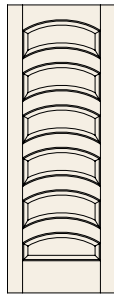

C60-A50

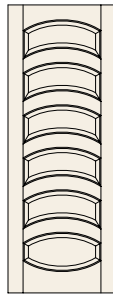

C60-A50B

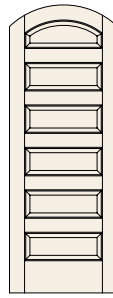

C60-AA

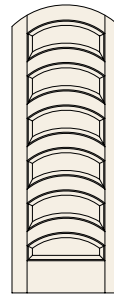

C60-AA50

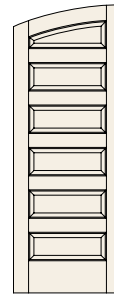

C60-S

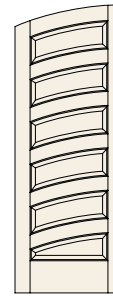

C60-S50

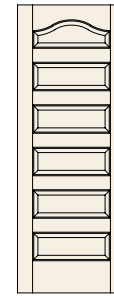

C60-CL

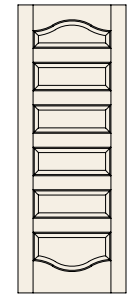

C60-CLB

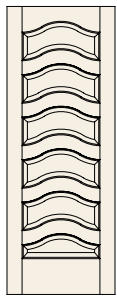

C60-CL55

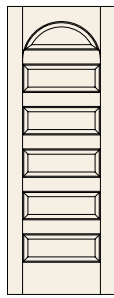

C60-R

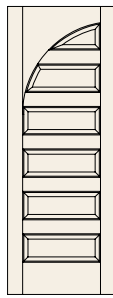

C60-HR

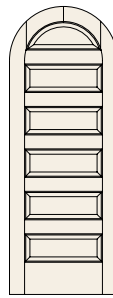

C60-RT

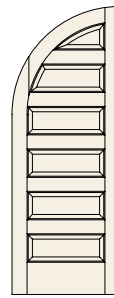

C60-HRT

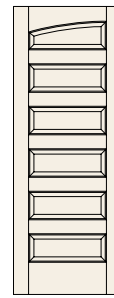

C60-HA

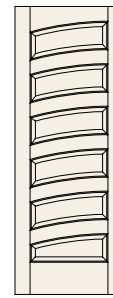

C60-HA50

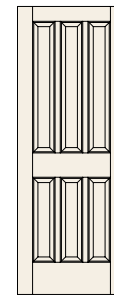

C61

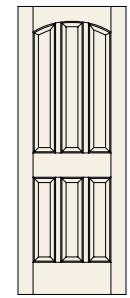

C61-A

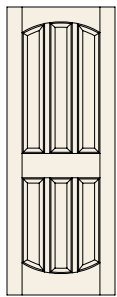

C61-AB

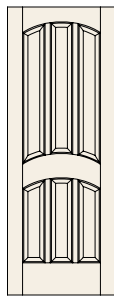

C61-A10

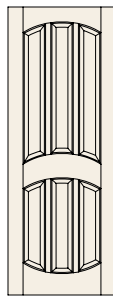

C61-A10B

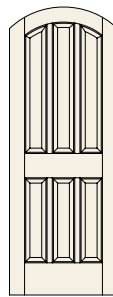

C61-AA

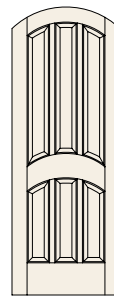

C61-AA10

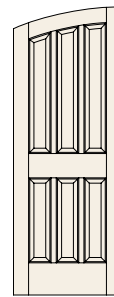

C61-S

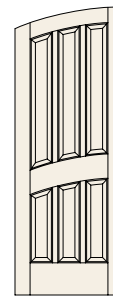

C61-S10

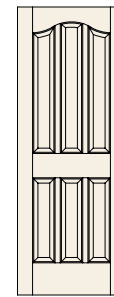

C61-CL

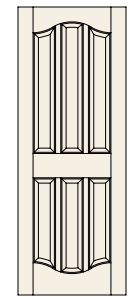

C61-CLB

LE CHATEAU 6 PANELS

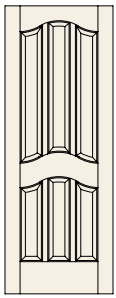

C61-CL15

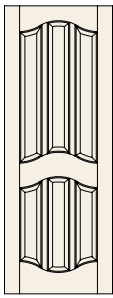

C61-CL15B

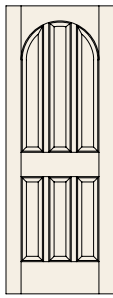

C61-R

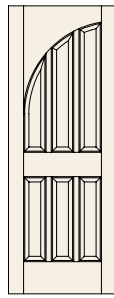

C61-HR

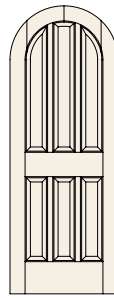

C61-RT

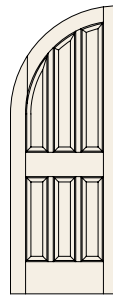

C61-HRT

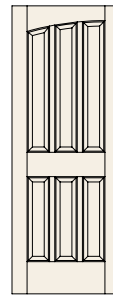

C61-HA

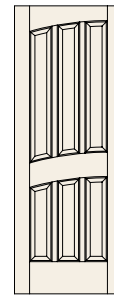

C61-HA10

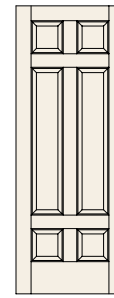

C62

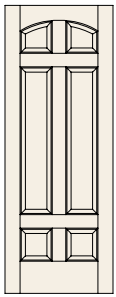

C62-A

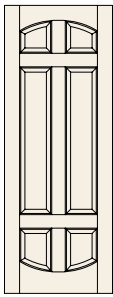

C62-AB



C62-A20

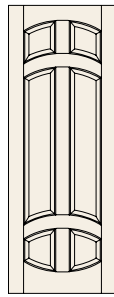

C62-A20B

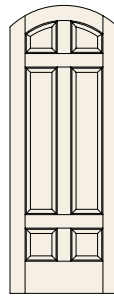

C62-AA

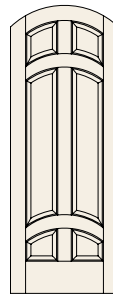

C62-AA20

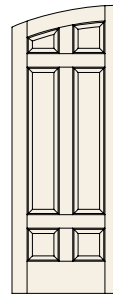

C62-S

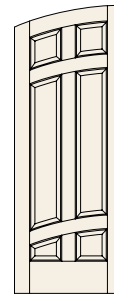

C62-S20

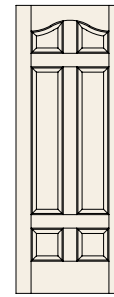

C62-CL

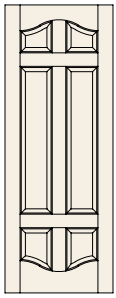

C62-CLB

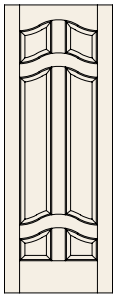

C62-CL25



C62-CL25B

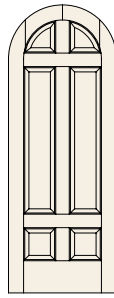

C62-RT

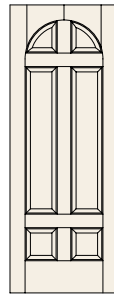

C62-R

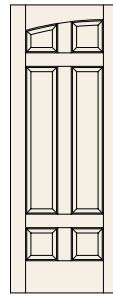

C62-HA

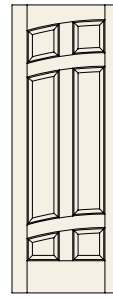

C62-HA20

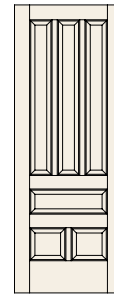

C63

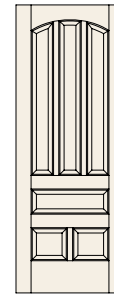

C63-A

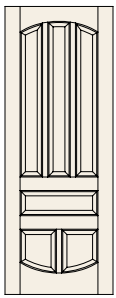

C63-AB

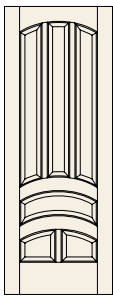

C63-A20

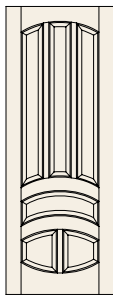

C63-A20B

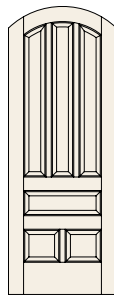

C63-AA

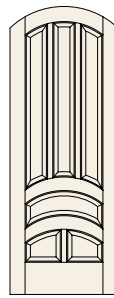

C63-AA20

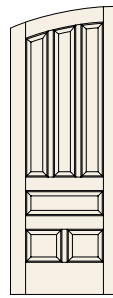

C63-S

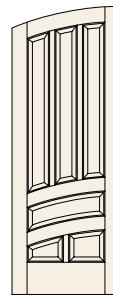

C63-S20

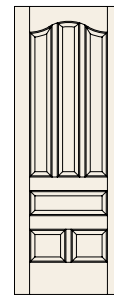

C63-CL

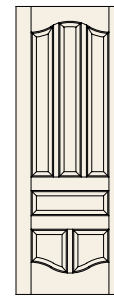

C63-CLB

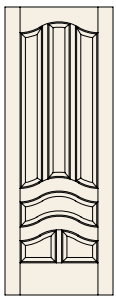

C63-CL25

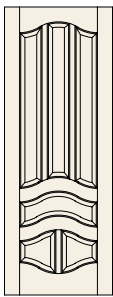

C63-CL25B

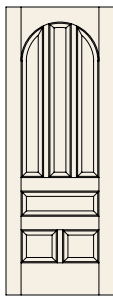

C63-R

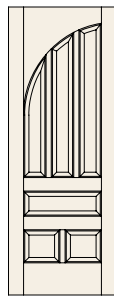

C63-HR

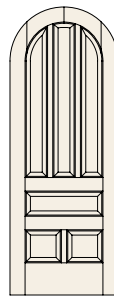

C63-RT

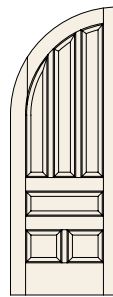

C63-HRT

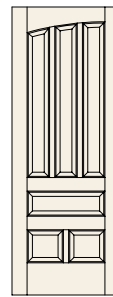

C63-HA

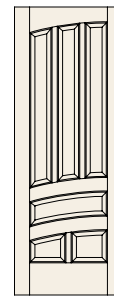

C63-HA20

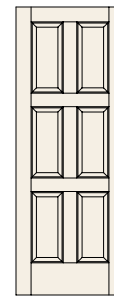

C64

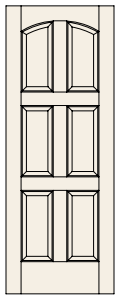

C64-A

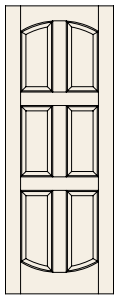

C64-AB

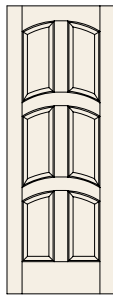

C64-A20

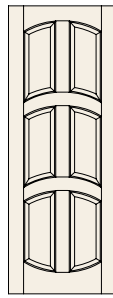

C64-A20B

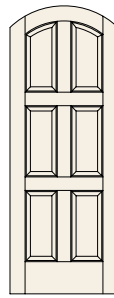

C64-AA

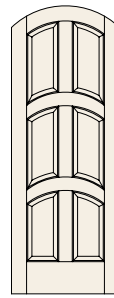

C64-AA20

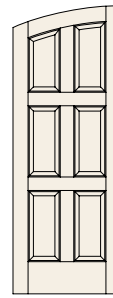

C64-S

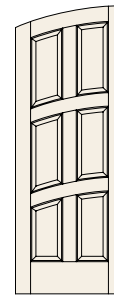

C64-S20

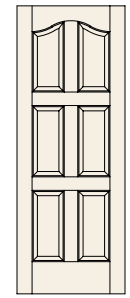

C64-CL

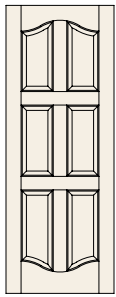

C64-CLB

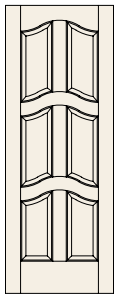

C64-CL25

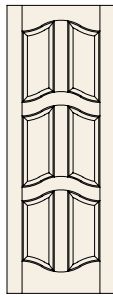

C64-CL25B

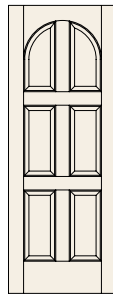

C64-R

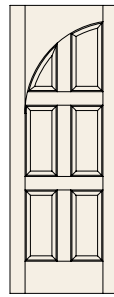

C64-HR

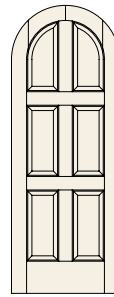

C64-RT

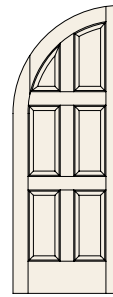

C64-HRT

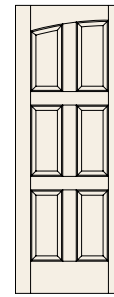

C64-HA

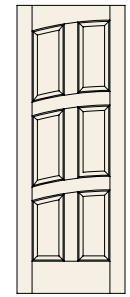

C64-HA20

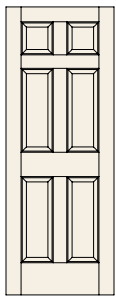

C66

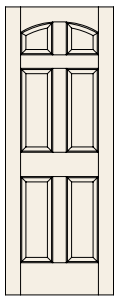

C66-A

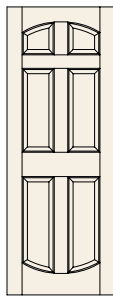

C66-AB

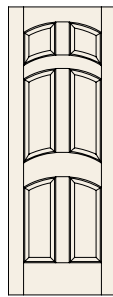

C66-A20

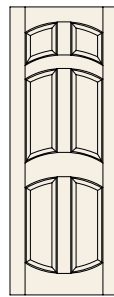

C66-A20B

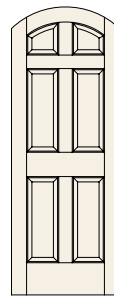

C66-AA

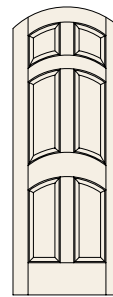

C66-AA20

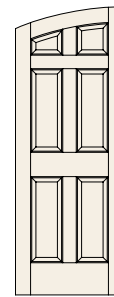

C66-S

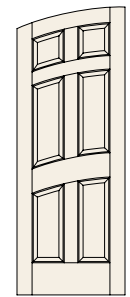

C66-S20

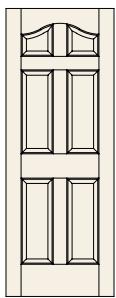

C66-CL

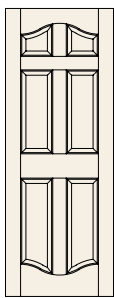

C66-CLB

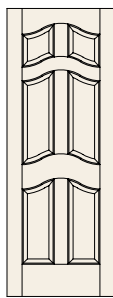

C66-CL25

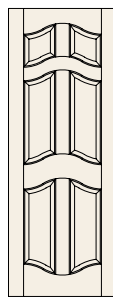

C66-CL25B

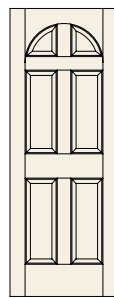

C66-R

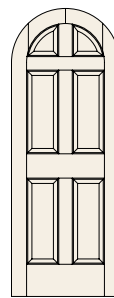

C66-RT

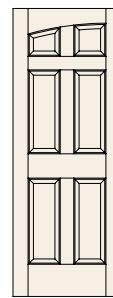

C66-HA

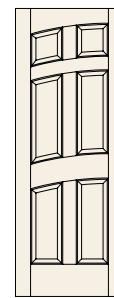

C66-HA20

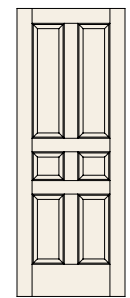

C67

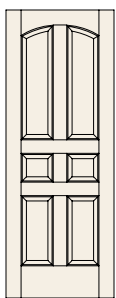

C67-A

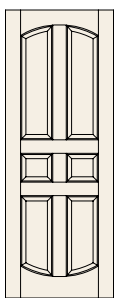

C67-AB

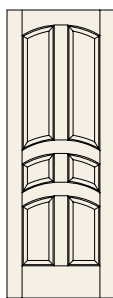

C67-A20

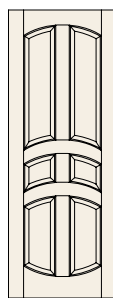

C67-A20B

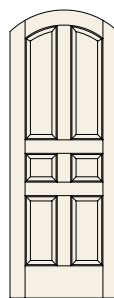

C67-AA

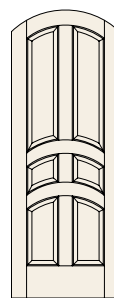

C67-AA20

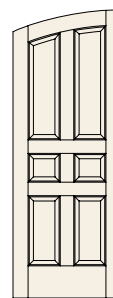

C67-S

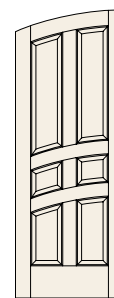

C67-S20

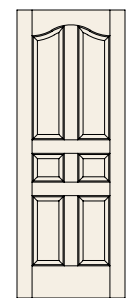

C67-CL

LE CHATEAU 6 OR MORE PANELS

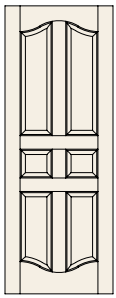

C67-CLB

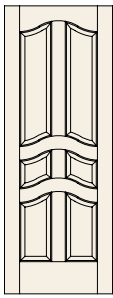

C67-CL25

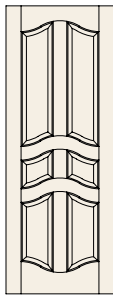

C67-CL25B

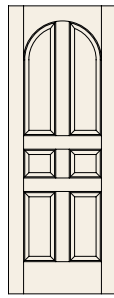

C67-R

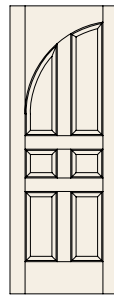

C67-HR

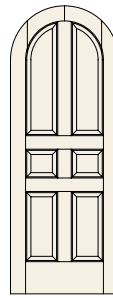

C67-RT

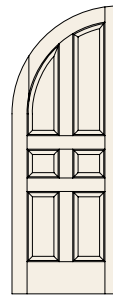

C67-HRT

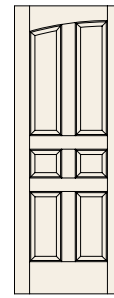

C67-HA

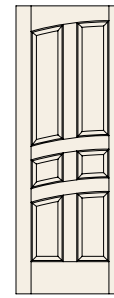

C67-HA20

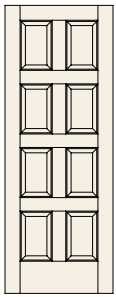

C88

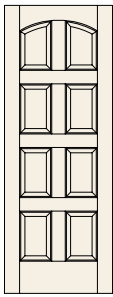

C88-A

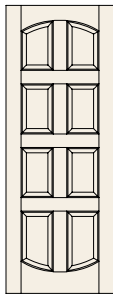

C88-AB

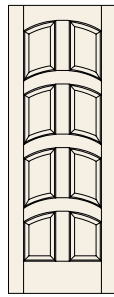

C88-A30

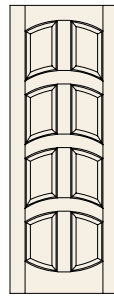

C88-A30B

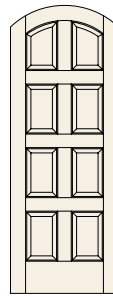

C88-AA

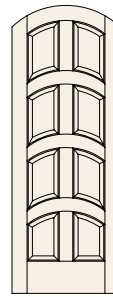

C88-AA30

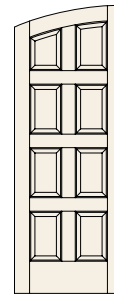

C88-S

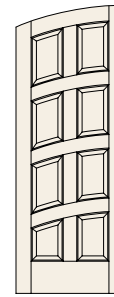

C88-S30

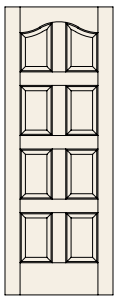

C88-CL

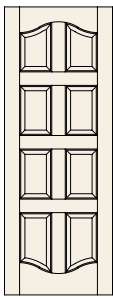

C88-CLB

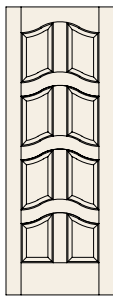

C88-CL35

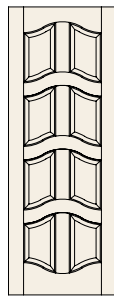

C88-CL35B

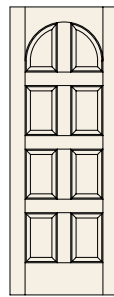

C88-R

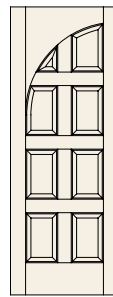

C88-HR

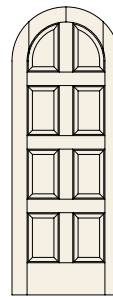

C88-RT

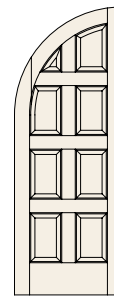

C88-HRT

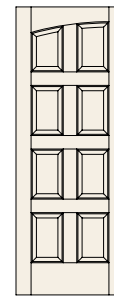

C88-HA

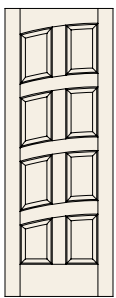

C88-HA30

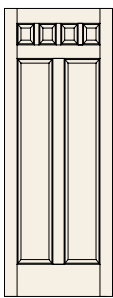

800

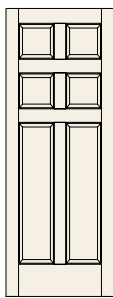

801

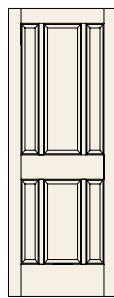

802

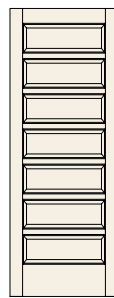

803

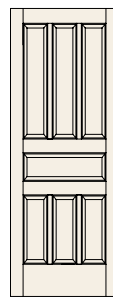

804

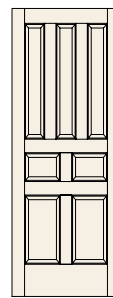

805

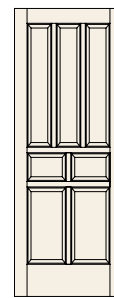

806

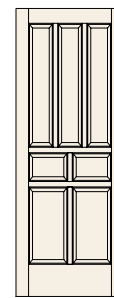

807

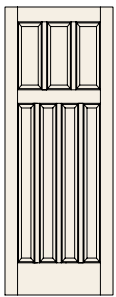

808

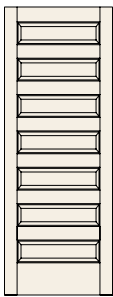

809

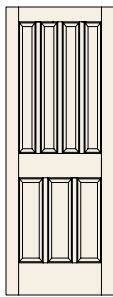

810

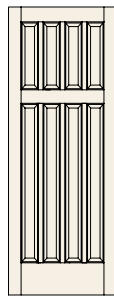

811

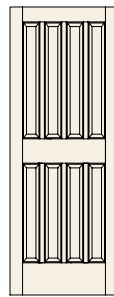

812

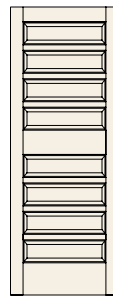

813

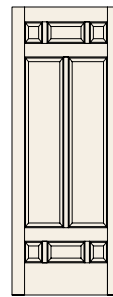

814

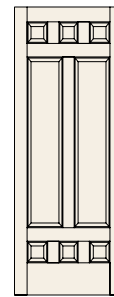

815

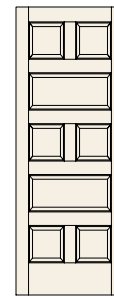

900

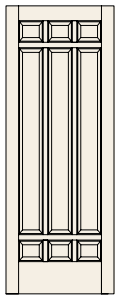

901

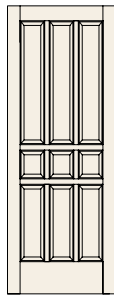

902

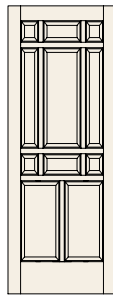

903

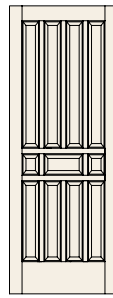

904

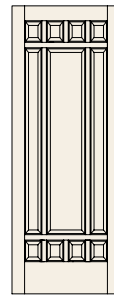

905



906

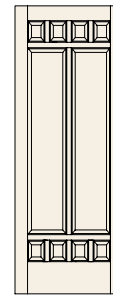

907

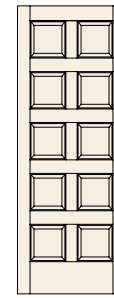

908

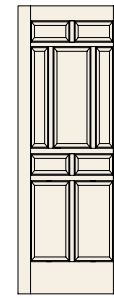

909

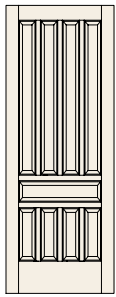

910

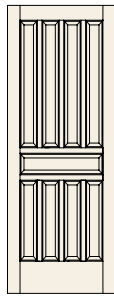

911

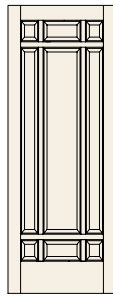

912

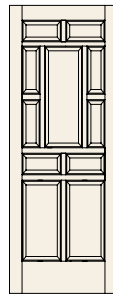

913

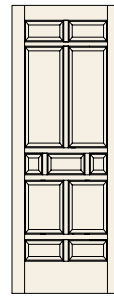

914

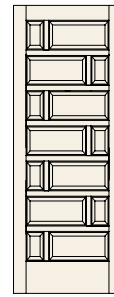

915

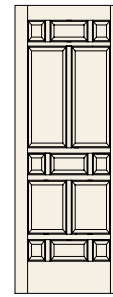

1000

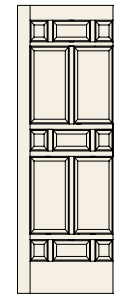

1001

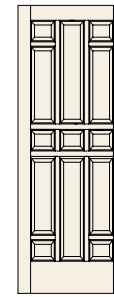

1002

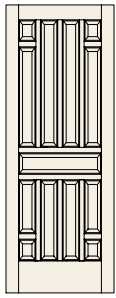

1003

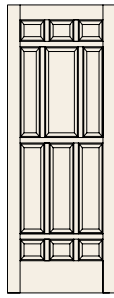

1004

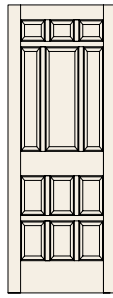

1005

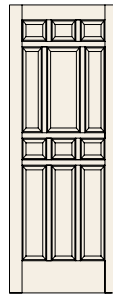

1006

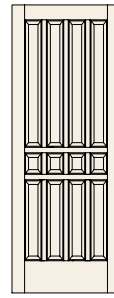

1007



1008

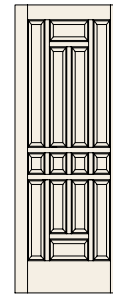

1009

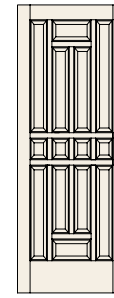

1010



1011

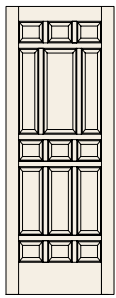

1012

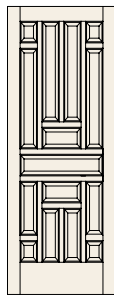

1013

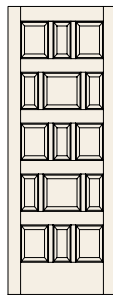

1014

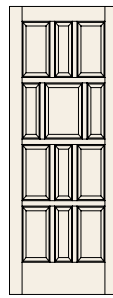

1015

LOUVERS & BIFOLDS

OPEN AND AIRY BUILDS CHARACTER

Practical elements and classic designs make our Louver Doors an ideal choice for air ventilation and visual inspiration between rooms.

- Quality louver construction for years of enjoyment
- Coordinate your home with appealing space-saving bifolds
- Pre-sanded and ready to stain or paint to match your décor



Door: Primed Plantation Louver over Louver
Bifold: Primed Plantation Louver over Louver

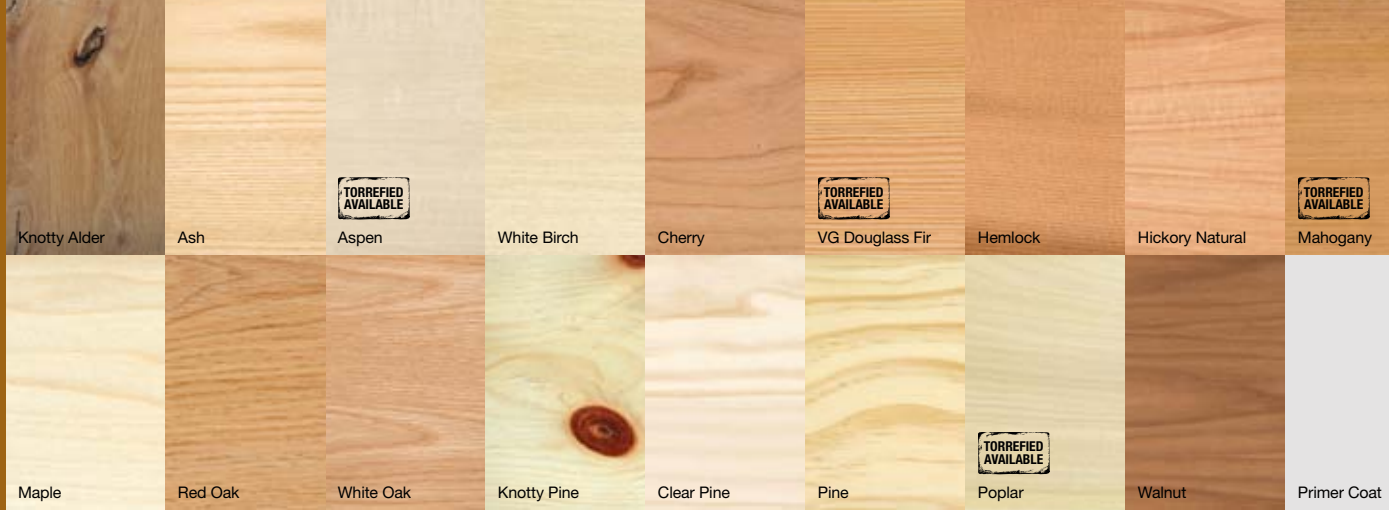

Louwer over Louwer
Shown in Clear Pine



Louwer over Panel
Shown in Finger Jointed Pine Primed



Plantation Louwer over Louwer
Shown in Finger Jointed Pine Primed



Plantation Louwer over Panel
Shown in Clear Pine



Louwer over Louwer Bifold
Shown in Clear Pine



Louwer over Panel Bifold
Shown in Clear Pine



Plantation Louwer over Louwer Bifold
Shown in Finger Jointed Pine Primed



Plantation Louwer over Panel Bifold
Shown in Clear Pine



Door: C316REV

58 LEMIEUX DOORS

WWW.TRICONTRUSS.CA

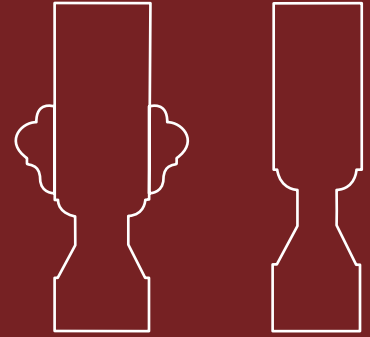

Available in Smooth and Raised Moulding Profiles

ROUTER CARVED MDF COLLECTION

The Router Carved MDF collection offers 65 surprisingly affordable designer carved doors, available in a wide variety of popular designs. Router Carved MDF doors are an excellent value for dealers who want to offer customers a full line of designer carved doors or for the discriminating homeowner and custom home builder.

- Available in 1-3/8" and 1-3/4" thicknesses
- Sizes up to 3'6" wide and up to 8'0" high
- Solid, one-piece wood composite construction will not warp, shrink or expand
- Engineered hinge edge for strong screw-holding power
- Radius corner profile edges allow for quick turnaround
- 20, 45, 60 and 90 minute fire-rated doors available
- Limited lifetime warranty

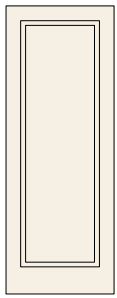

C101REV

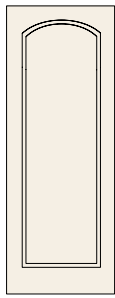

C102REV

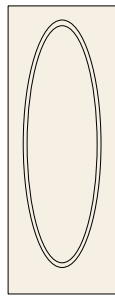

C103REV

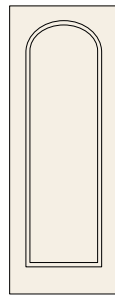

C104REV

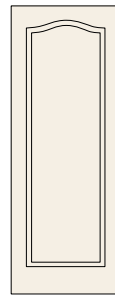

C105REV

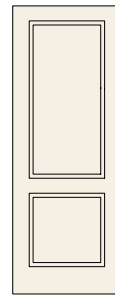

C201REV

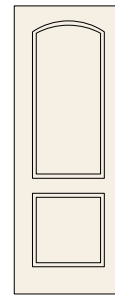

C202REV

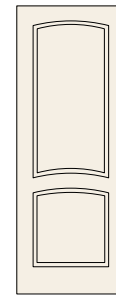

C203REV

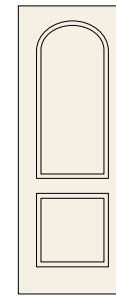

C204REV

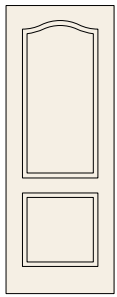

C205REV

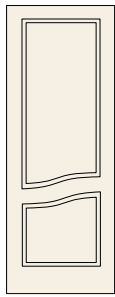

C208REV

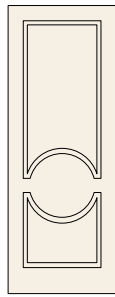

C211REV

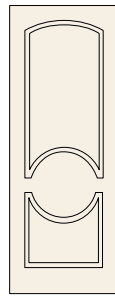

C212REV

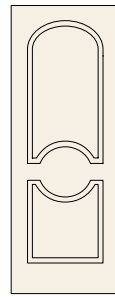

C213REV

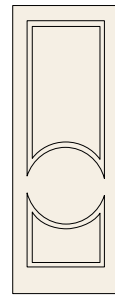

C215REV

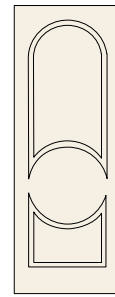

C217REV

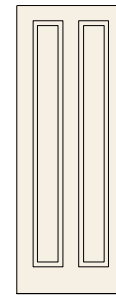

C219REV



C220REV

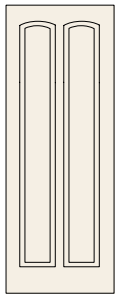

C221REV

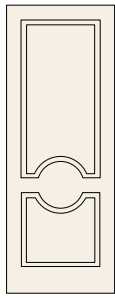

C222REV

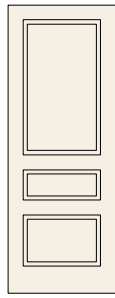

C301REV

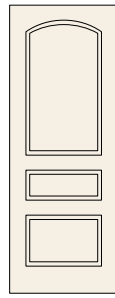

C302REV

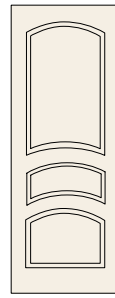

C303REV

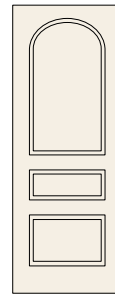

C304REV

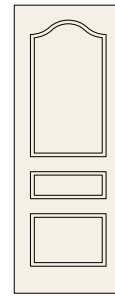

C305REV

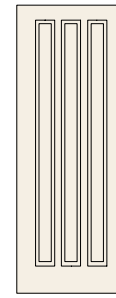

C308REV



C310REV

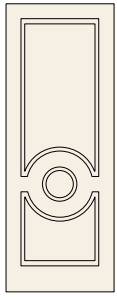

C311REV

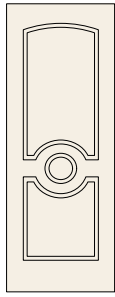

C312REV

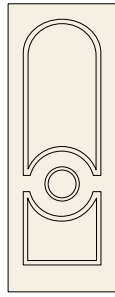

C313REV

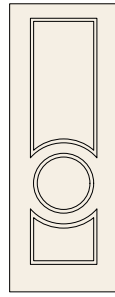

C315REV

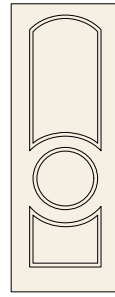

C316REV

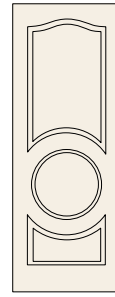

C318REV

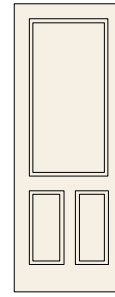

C319REV

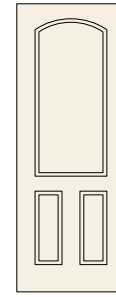

C320REV

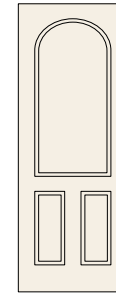

C321REV

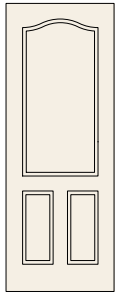

C322REV

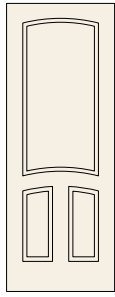

C323REV

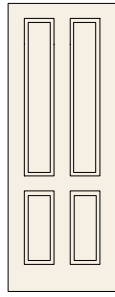

C401REV

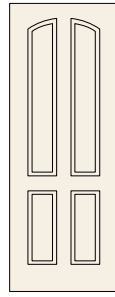

C402REV



C403REV

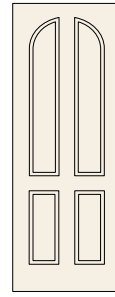

C404REV

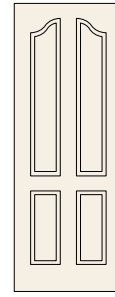

C405REV

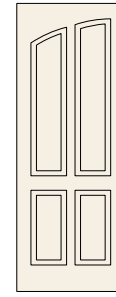

C406REV



C408REV

ROUTER CARVED MDF

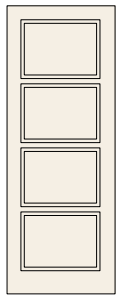

C410REV

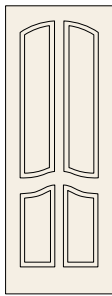

C411REV

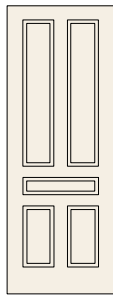

C501REV

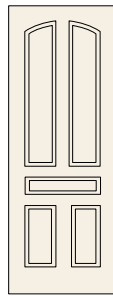

C502REV



C503REV

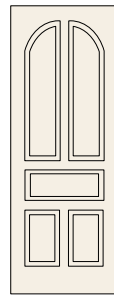

C504REV

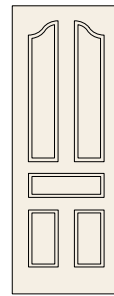

C505REV

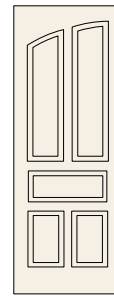

C506REV

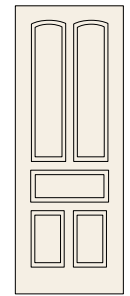

C508REV



C510REV



C511REV

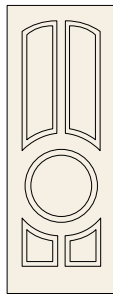

C512REV

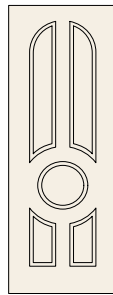

C513REV



C514REV

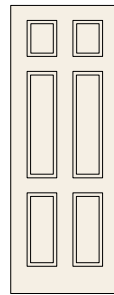

C601REV

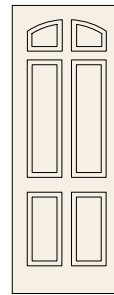

C602REV

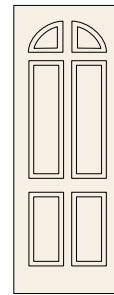

C604REV

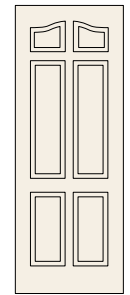

C605REV

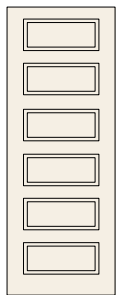

C610REV

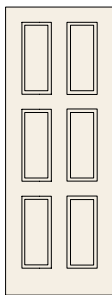

C611REV



Door: C201REV



Door: Torrefied Douglas Fir 2662A w/ Narrow Reed glass

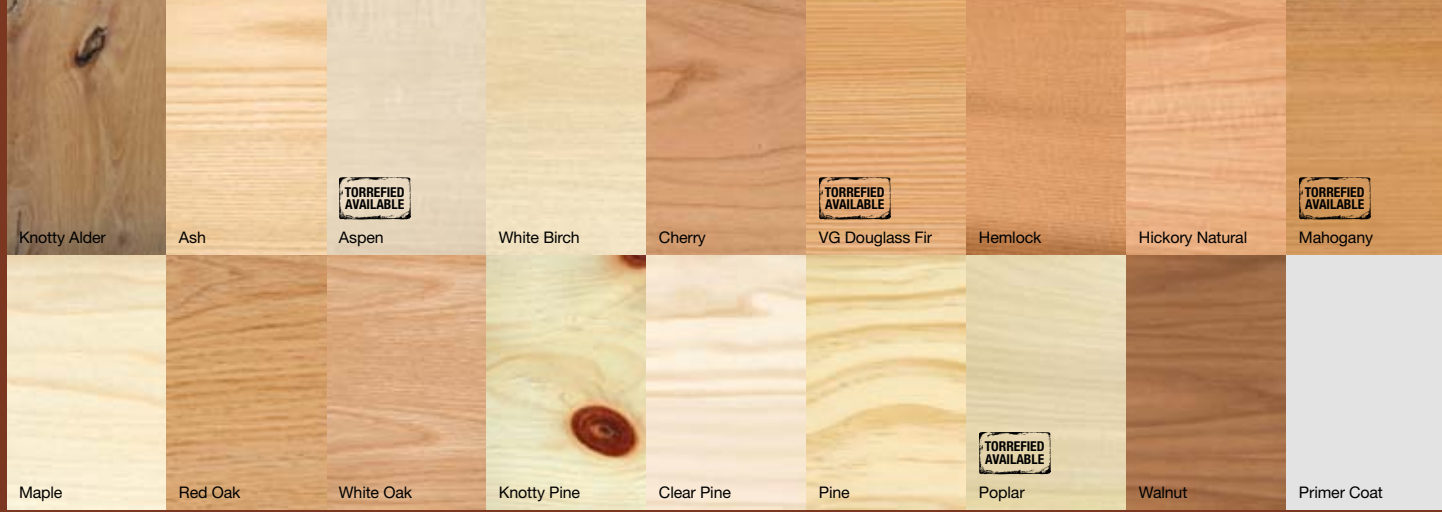

ARTISAN COLLECTION

The charm of the countryside is captured in the Artisan Collection. Their rustic appeal well deserved: these are doors built by true craftsmen! Unparalleled attention to detail and quality aside, they're among the best doors available today – complete with durable MDF panel components and a solid warranty against splitting. We also offer nature's own Solid Wood panels, with our entire selection of species and designs available. Add to that raised mouldings, top rail designs and the widest selection of glazing offered by any door maker, and you'll realize just how easily the Artisan Collection can deliver a unique door created expressly for you and your home décor.

Explore our wide range of glazing on pages 24 to 27.

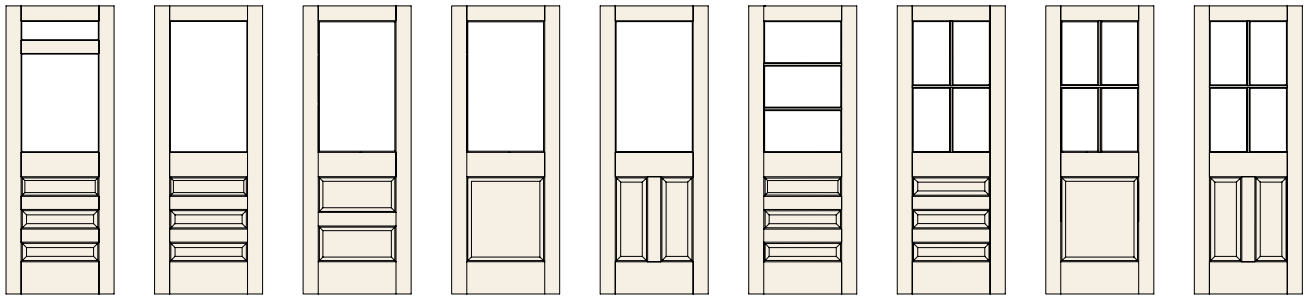

117 118 122 142 144 318 418 442 444

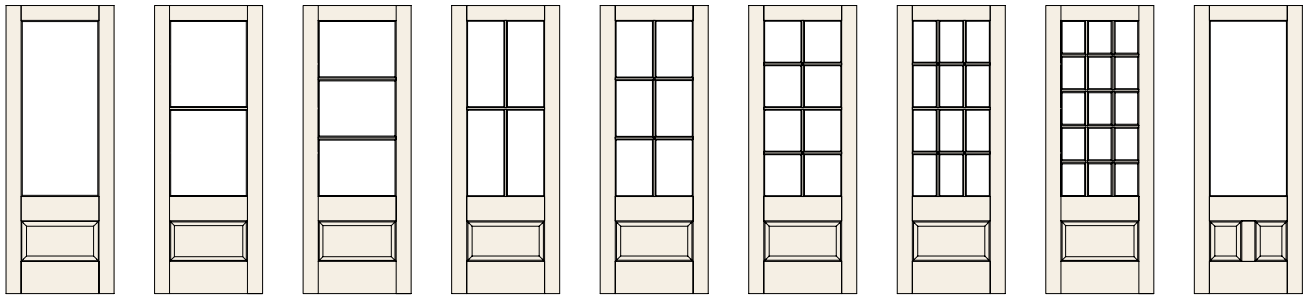

501 502 503 504 506 508 512 515 521

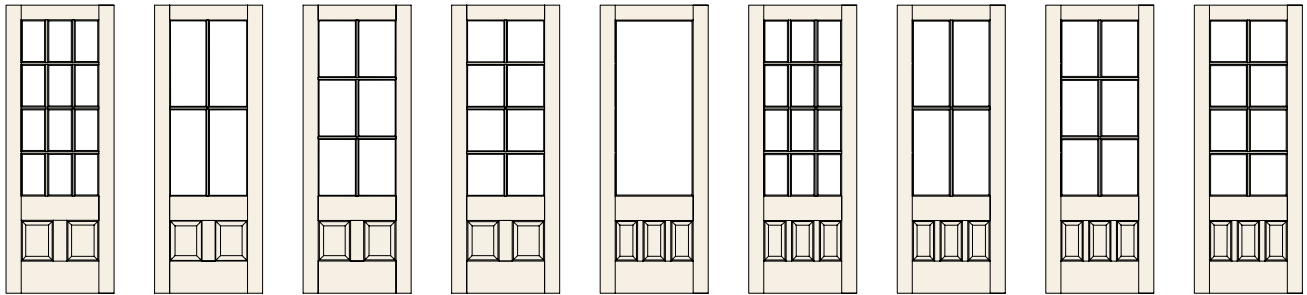

522 524 526 528 531 532 534 536 538

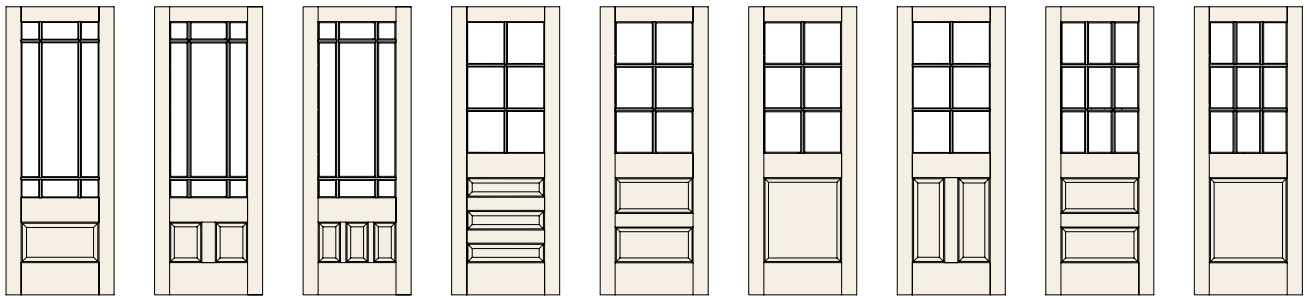

543 546 549 618 622 642 644 922 942

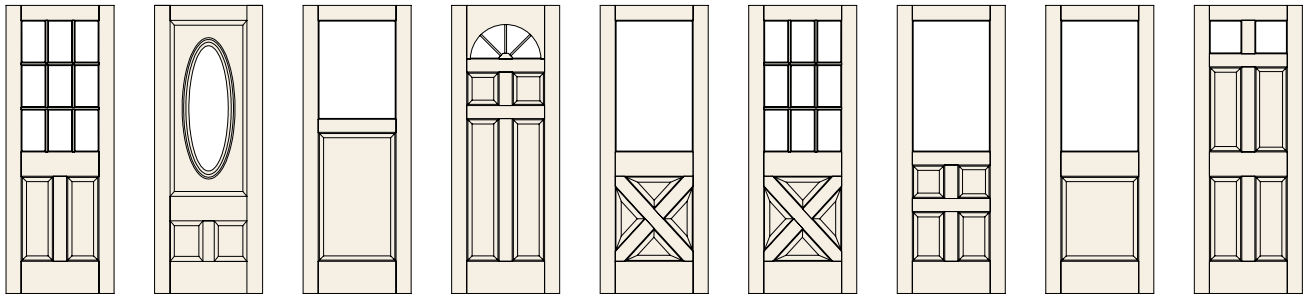

944 1020 2008 2020 2031 2035 2071 2081 2132

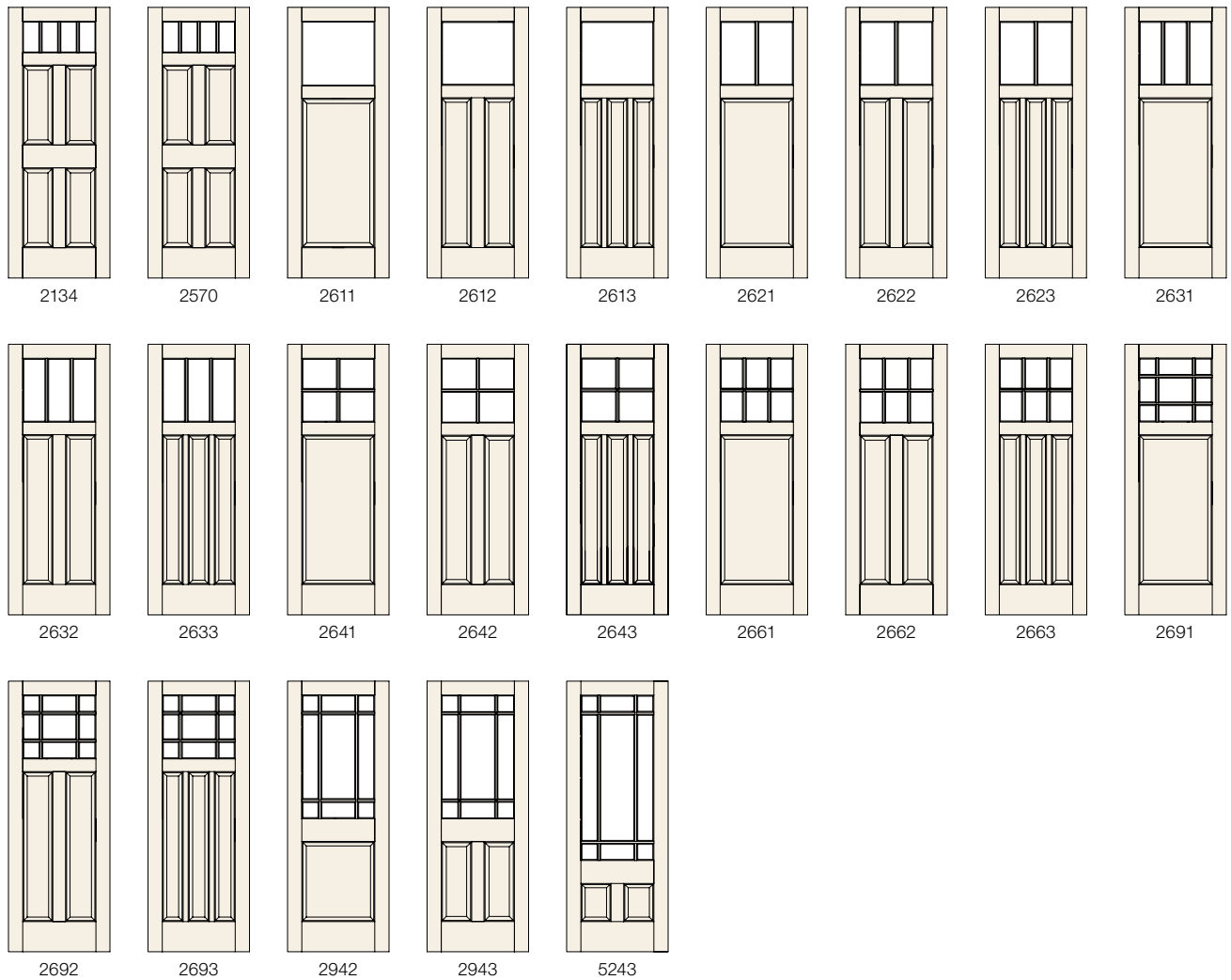

Hemlock 2642 IG DH w/ LVL stiles



SIDELIGHTS & TRANSOMS



Door: Oak 808 IG Seedy Baroque glass DH
Sidelight: Oak 1761 IG seedy Baroque glass DH
Transom: T71 IG Seedy Baroque glass
(All with LVL stiles)

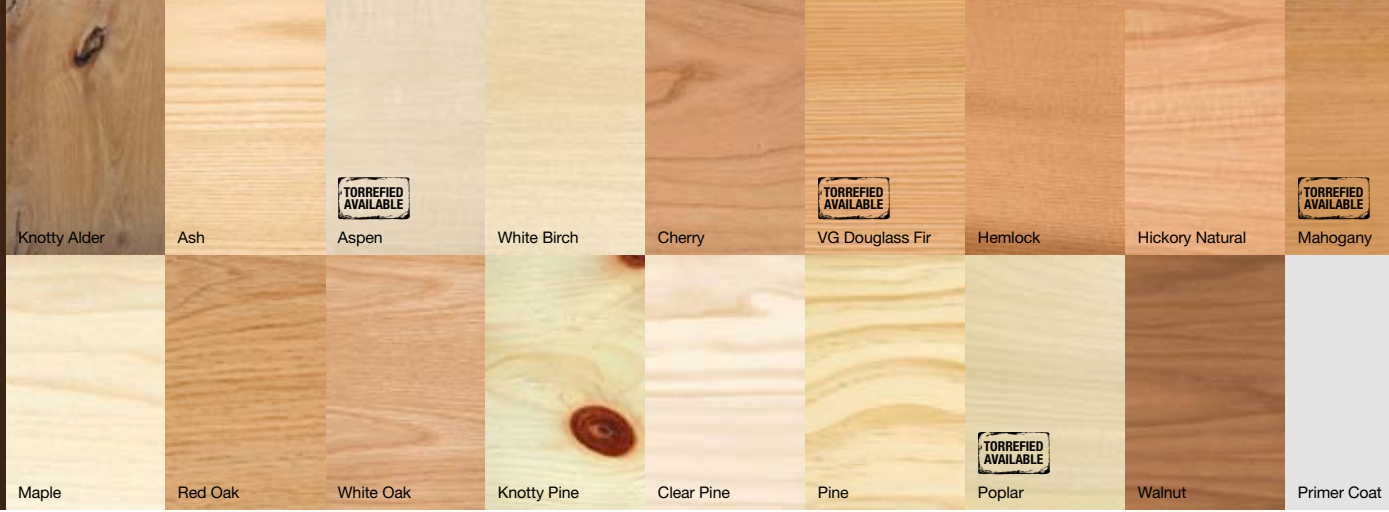

MAKE YOUR DOORS STAND OUT EVEN MORE BY ADDING SIDELIGHTS AND A TRANSOM.

They will brighten any room, bathing it in natural light. It's a refreshing accent that will bring your home to life.

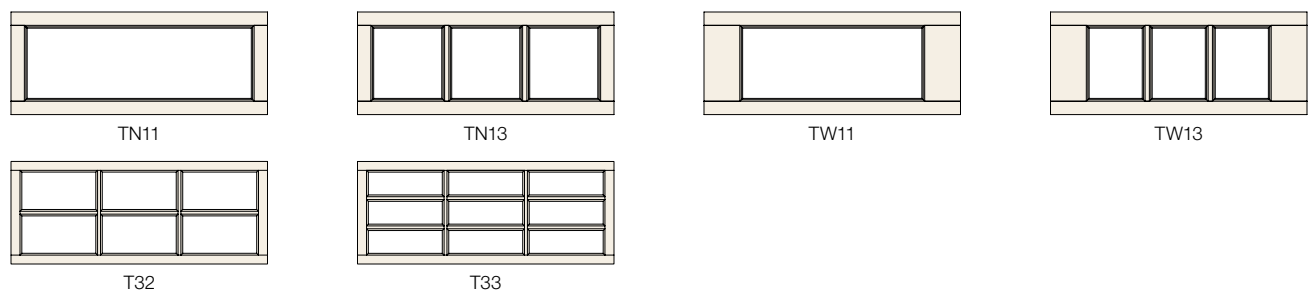
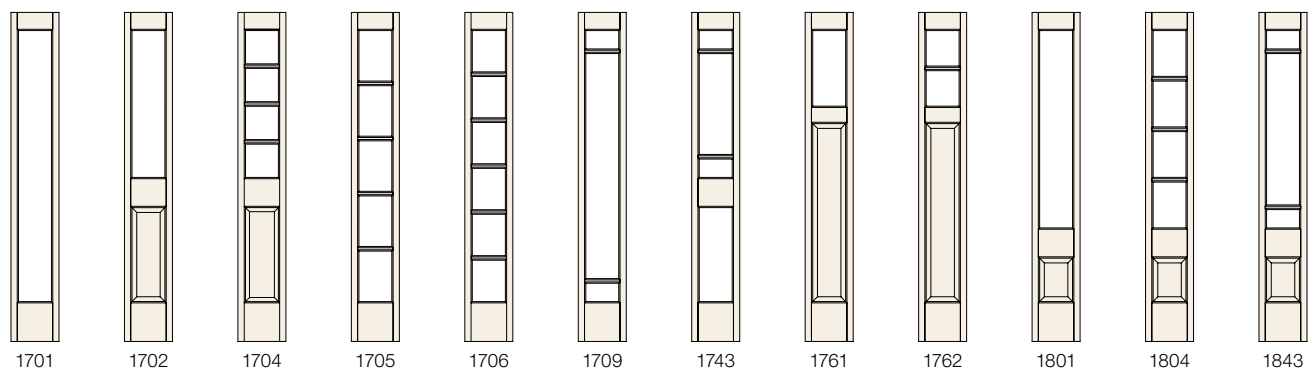



A division of Masonite International



Door: Oak 2081arch/arch IG w/ LVL stiles.



Masonite®, Masonite, The Beautiful door™ and Lemieux Doors are trademarks of Masonite International Corporation. Please check with your Lemieux dealer or distributor for current warranty terms and conditions. Our continuing program of product improvement makes specification, design and product detail subject to change without notice. Due to limitations of the printing process, doors, glass and colors may not match exactly to actual products shown. 86911057 1/13 Printed in Canada. © 2013 by Masonite International Corporation. www.masonite.com

WWW.TRICONTRUSS.CA

MIC-12327 / 9279