



FYPON[®] PRODUCTS

REEB[®] IN-STOCK DECORATIVE MILLWORK CATALOG





TABLE OF CONTENTS

INTRODUCTION 3

WINDOW & DOOR TRIM 4

- 6" Classic Crossheads 6
- Large Door Crosshead 7
- 9" Classic Crossheads 8-10
- Keystones 10
- Trimmable Distinction Crossheads 12
- Trimmable Craftsman Crossheads 13
- Pediments 14-15
- Pilasters 16-18
- Trim 18-19
- Door Surround Kits 20-23
- Shutters 25

MOULDING 26

- Smooth Flat Trim 28
- Crown Mouldings 29-30
- Dentil Mouldings 32-34
- Base Cap 35
- Chair Rail 36
- Window & Door Trim 37
- Assorted 37
- Moulding Accessories 37

DECORATIVE MILLWORK 38

- Brackets 40-46
- Smooth Dentil Blocks 46-47
- Knee Braces 48
- Porch Spandrels 48
- Finials 48
- Gable Pediments 49
- Rafter Tails 50
- Beam Mantels 51

LOUVERS 52

- Cathedral Louvers 54
- Eyebrow Louvers 55
- Vertical Louvers 55
- Round Louvers 56-57
- Half Round Louver 57
- Oval Louvers 58
- Triangle Louvers 58

BALUSTRADE SYSTEM 60

- Balusters 62-63
- Straight Rails 65
- Newel Posts 66
- Post Accessories 67

INDEX 68-70

ADHESIVE 71

CUTTING & MILLING 71



STYLE, PERFORMANCE, SERVICE. THAT'S THE FYPON® ADVANTAGE.

INTRODUCTION

Fypon offers a unique way to add distinction with historically accurate products that bring out the best of any home. Each product in this catalog includes the sizing (width, height, length, and projection), a detailed drawing, and the part number for easy ordering. For quick and easy reference, this catalog has been divided into major product categories. If you don't see a product you normally purchase, contact Reeb's Customer Service department to help you find what you need.

INVENTORY

Reeb® stocks an extensive amount of Fypon products because investing in quality decorative millwork means transforming the basic design of a home into a true work of art. From subtle enhancements like eye-catching brackets and balustrades to dramatic archways and exquisite mouldings, quality Fypon products will add to the décor of any home.

POLYURETHANE MILLWORK

The first step in manufacturing polyurethane millwork is to create molds that will be used. A coat of primer paint is sprayed into the mold. Once the primer has dried, the urethane foam is poured into the mold, and then placed in a press. After the foam cures and hardens in the shape, the mold can be removed from the press in preparation for finishing the product. The product is removed from the mold and is inspected for quality. A second coat of primer is applied and the product is boxed and readied for shipment.

FEATURES AND BENEFITS

- Low-maintenance product
- Lightweight and easy to install
- No stain or paint prep needed
- Can be cut, trimmed or shaped like wood using standard woodworking tools
- Resists moisture and insects
- Won't warp, crack, rot or split
- Backed by a lifetime limited warranty

FYPON SERVICE

Building professionals trust Fypon to deliver outstanding customer service and support by providing:

- Drawings and marketing support for blueprints and model homes
- An industry-first quote package program with quantity pricing tool
- Support from Fypon experts and answers to common installation questions
- Custom design services for historical restorations, replicas or any unique profile that fits your home or commercial application.

WINDOW & DOOR TRIM

AN UNFORGETTABLE FIRST IMPRESSION.

Transform the look of any home with Fypon® Window and Door Trim. Designed to work together, these pieces are quick and easy to install.



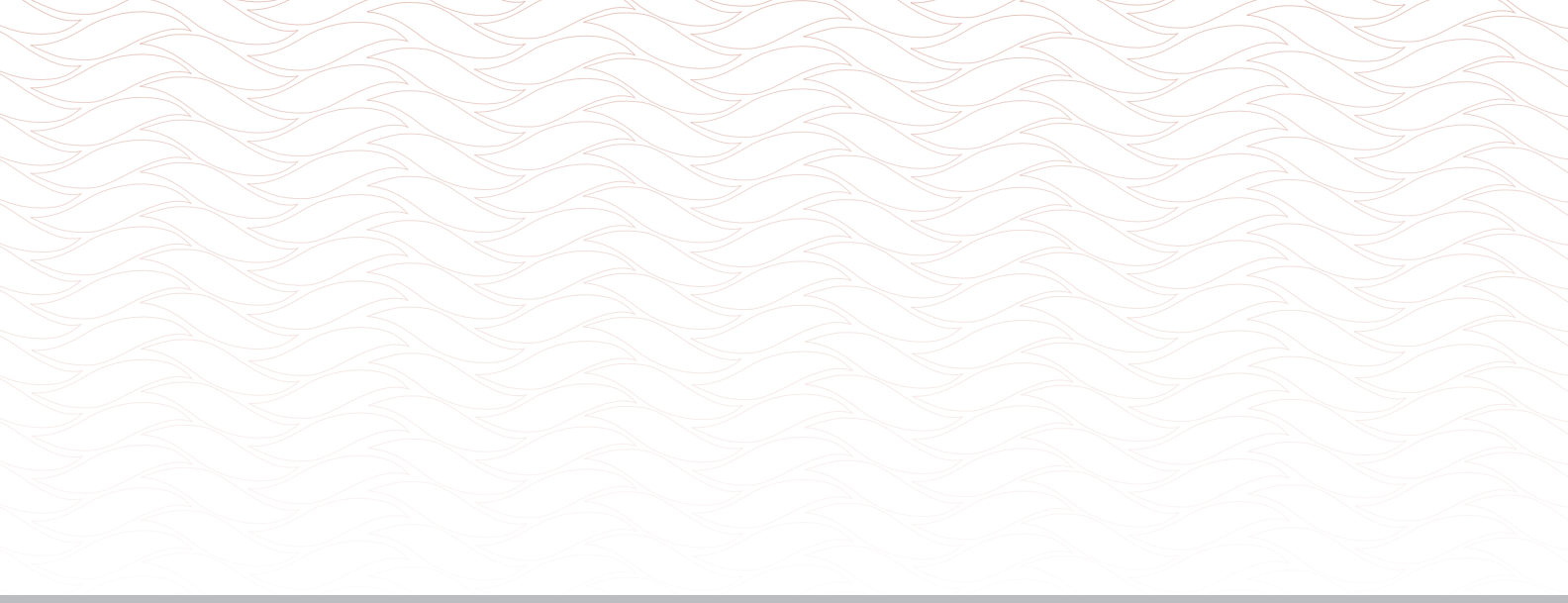

Fypon offers a wide range of styles and sizes of window and door trim to take the look of a home from ordinary to extraordinary. For the exterior of a home, use Fypon crossheads and pediments to add an extra touch above the doors and windows. Pilasters finish off the side of the doors or windows with a more refined and finished look. Fypon trim creates a customized window while accessories like keystones add additional curb appeal. Fypon shutters are a lightweight polyurethane that is quick and easy to install.

ORDERING

When ordering trim for doors or windows, first measure the door unit to be trimmed. The unit can be measured with or without brickmould, however the brickmould is essential when using a storm door. Next, choose the desired pilaster style and size. Finally, choose a pediment or crosshead that is wide enough to span the opening plus the brickmould and pilasters.

Products in this section are organized by style then width and door surround kits are organized by unit configuration and then by overall unit width. Where applicable, part numbers are shown for products with available unattached accessories. A urethane-based adhesive must be used on all joint surfaces. For more information, please see page 71.

WINDOW & DOOR TRIM

6" CLASSIC CROSSHEAD

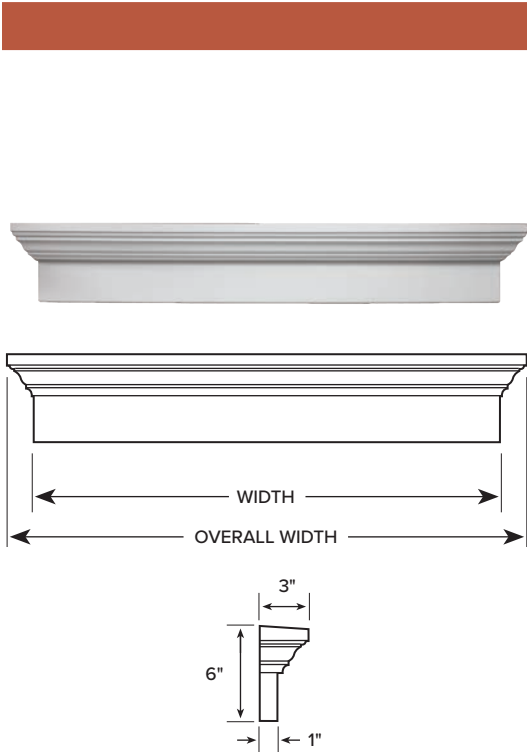

Part Number	Width	Overall Width	Part Number	Width	Overall Width
WCH24X6	24"	27-1/2"	WCH51X6	51"	54-1/2"
WCH28X6	28"	31-1/2"	WCH52X6	52"	55-1/2"
WCH30X6	30"	33-1/2"	WCH56X6	56"	59-1/2"
WCH32X6	32"	35-1/2"	WCH60X6	60"	63-1/2"
WCH33X6	33"	36-1/2"	WCH64X6	64"	67-1/2"
WCH34X6	34"	37-1/2"	WCH66X6	66"	69-1/2"
WCH35X6	35"	38-1/2"	WCH68X6	68"	71-1/2"
WCH36X6	36"	39-1/2"	WCH72X6	72"	75-1/2"
WCH37X6	37"	40-1/2"	WCH73X6	73"	76-1/2"
WCH38X6	38"	41-1/2"	WCH74X6	74"	77-1/2"
WCH40X6	40"	43-1/2"	WCH76X6	76"	79-1/2"
WCH41X6	41"	44-1/2"	WCH78X6	78"	81-1/2"
WCH43X6	43"	46-1/2"	WCH80X6	80"	83-1/2"
WCH44X6	44"	47-1/2"	WCH84X6	84"	87-1/2"
WCH46X6	46"	49-1/2"	WCH96X6	96"	99-1/2"
WCH47X6	47"	50-1/2"	WCH100X6	100"	103-1/2"
WCH48X6	48"	51-1/2"	WCH104X6	104"	107-1/2"
WCH50X6	50"	53-1/2"	WCH108X6	108"	111-1/2"
			WCH144X6	144"	147-1/2"

6" CLASSIC CROSSHEAD WITH KEYSTONE APPLIED

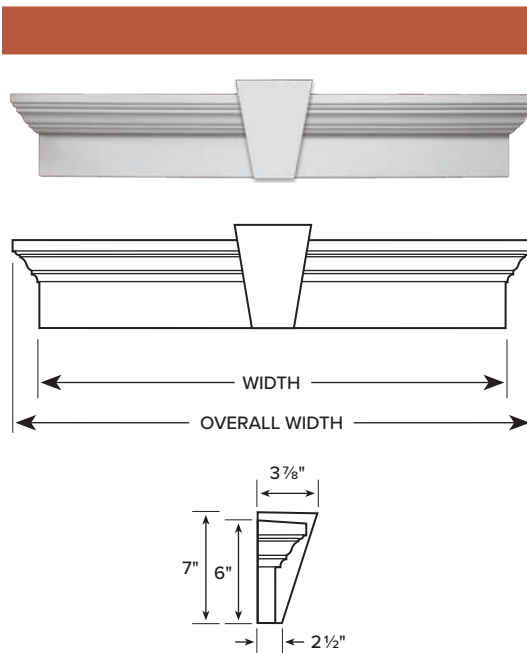

Part Number	Width	Overall Width
WCH36X6K	36"	39-1/2"
WCH37X6K	37"	40-1/2"
WCH40X6K	40"	43-1/2"
WCH44X6K	44"	47-1/2"
WCH48X6K	48"	51-1/2"
WCH72X6K	72"	75-1/2"
WCH80X6K	80"	83-1/2"



LARGE DOOR CROSSHEAD

Part Number	Width	Overall Width
-------------	-------	---------------

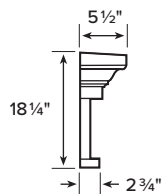
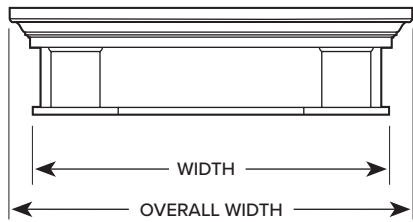

LDCH58X18	58"	67-1/2"
-----------	-----	---------

LDCH58X18

58"

67-1/2"

WINDOW & DOOR TRIM

9" CLASSIC CROSSHEAD

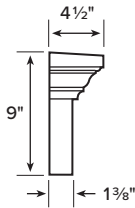

Part Number	Width	Overall Width	Part Number	Width	Overall Width
WCH24X9	24"	29-1/2"	WCH69X9	69"	74-1/2"
WCH25X9	25"	30-1/2"	WCH70X9	70"	75-1/2"
WCH28X9	28"	33-1/2"	WCH72X9	72"	77-1/2"
WCH32X9	32"	37-1/2"	WCH74X9	74"	79-1/2"
WCH33X9	33"	38-1/2"	WCH75X9	75"	80-1/2"
WCH34X9	34"	39-1/2"	WCH76X9	76"	81-1/2"
WCH35X9	35"	40-1/2"	WCH77X9	77"	82-1/2"
WCH36X9	36"	41-1/2"	WCH78X9	78"	83-1/2"
WCH37X9	37"	42-1/2"	WCH80X9	80"	85-1/2"
WCH38X9	38"	43-1/2"	WCH81X9	81"	86-1/2"
WCH40X9	40"	45-1/2"	WCH82X9	82"	87-1/2"
WCH41X9	41"	46-1/2"	WCH84X9	84"	89-1/2"
WCH42X9	42"	47-1/2"	WCH85X9	85"	90-1/2"
WCH43X9	43"	48-1/2"	WCH86X9	86"	91-1/2"
WCH44X9	44"	49-1/2"	WCH88X9	88"	93-1/2"
WCH45X9	45"	50-1/2"	WCH93X9	93"	98-1/2"
WCH46X9	46"	51-1/2"	WCH96X9	96"	101-1/2"
WCH48X9	48"	53-1/2"	WCH99X9	99"	104-1/2"
WCH50X9	50"	55-1/2"	WCH100X9	100"	105-1/2"
WCH54X9	54"	59-1/2"	WCH103X9	103"	108-1/2"
WCH56X9	56"	61-1/2"	WCH104X9	104"	109-1/2"
WCH58X9	58"	63-1/2"	WCH108X9	108"	113-1/2"
WCH60X9	60"	65-1/2"	WCH196X9	196"	201-1/2"
WCH64X9	64"	69-1/2"	WCH197X9	197"	202-1/2"
WCH67X9	67"	72-1/2"	WCH200X9	200"	205-1/2"
WCH68X9	68"	73-1/2"	WCH204X9	204"	209-1/2"

9" CLASSIC CROSSHEAD WITH KEYSTONE APPLIED

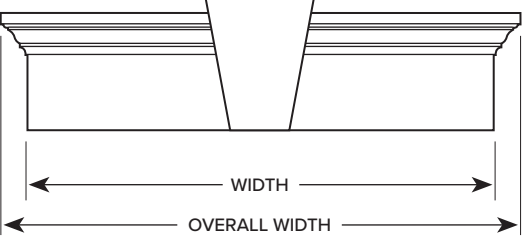
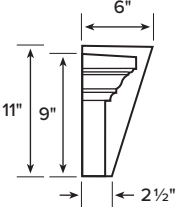
	Part Number	Width	Overall Width
  	WCH32X9K	32"	37-1/2"
	WCH33X9K	33"	38-1/2"
	WCH36X9K	36"	41-1/2"
	WCH37X9K	37"	42-1/2"
	WCH40X9K	40"	45-1/2"
	WCH44X9K	44"	49-1/2"
	WCH48X9K	48"	53-1/2"
	WCH64X9K	64"	69-1/2"
	WCH72X9K	72"	77-1/2"
	WCH80X9K	80"	85-1/2"
	WCH84X9K	84"	89-1/2"
	WCH100X9K	100"	105-1/2"
	WCH104X9K	104"	109-1/2"
WCH200X9K	200"	205-1/2"	

9" CLASSIC CROSSHEAD WITH 1" BOTTOM TRIM

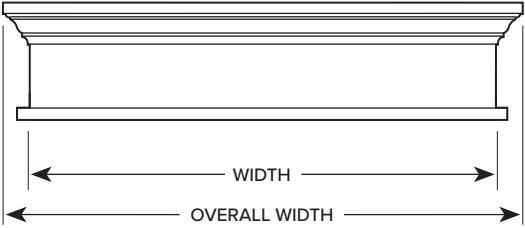
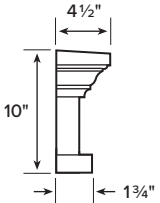

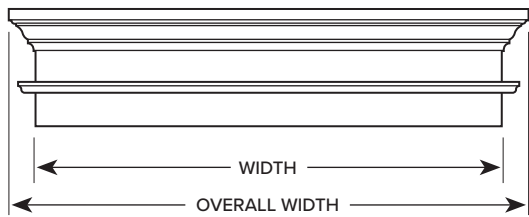
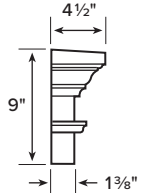

	Part Number	Width	Overall Width
  	WCH36X10BT	36"	41-1/2"
	WCH48X10BT	48"	53-1/2"
	WCH54X10BT	54"	59-1/2"

WINDOW & DOOR TRIM

9" CLASSIC CROSSHEAD WITH TRIM STRIP

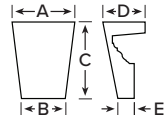
	Part Number	Width	Overall Width
  	WCH86X9T	86"	91-1/2"

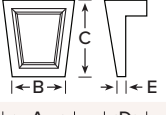

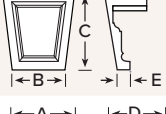
KEYSTONE

	Part Number	Top Width (A)	Bottom Width (B)	Height (C)	Top Projection (D)	Bottom Projection (E)	Arches & Trim
 	K6M	5-3/4"	4"	7"	3-7/8"	1-1/2"	6" WCH
	K9M	8"	6"	11"	6-1/8"	1-1/8"	9" WCH, 9" WCH w/ BT, 9" CH
 	KP6M	5-3/4"	4"	7"	4-1/8"	1-3/4"	6" WCH, 6" CH,
	KP9M	8"	6"	11"	6-1/4"	1-5/8"	9" WCH, 9" WCH w/ BT, 9" CH
 	K4TF	4-1/4"	3"	4-1/2"	2-1/4"	1/2"	4F Arches, FLT152
	K6TF	6"	4"	7"	2-3/8"	5/8"	6F Arches, FLT159
 	K4TM	4-1/4"	3"	4-1/2"	2-1/4"	3/4"	4M Arches, MLD215
	K6TM	6"	4"	7"	2-7/8"	7/8"	6M Arches, MLD220
	K10TM	8"	5-1/2"	11-1/2"	4"	1-3/4"	PIL10X96A
 	KP4TF	4-1/4"	3"	4-1/2"	2-1/4"	1/2"	4M Arch Trim, FTL152
 	KP4TM	4-1/4"	3"	4-1/2"	2-3/4"	3/4"	4M Arch Trim, MLD215
 	KWM180M	2-3/4"	2"	3-1/8"	2-1/2"	—	Brickmould Louvers/ Trim





WINDOW & DOOR TRIM

6" TRIMMABLE DISTINCTION CROSSHEAD

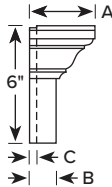
CROSSHEAD				
		Part Number	Overall Width	
		CHT36X6	36"	
		CHT48X6	48"	
		CHT144X6	144-3/8"	

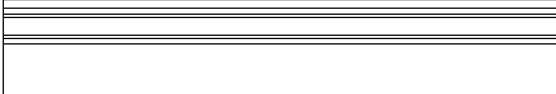

END CAPS*					
		Part Number	Overall Width (A)	Width (B)	Rabbet Width (C)
		CHC2X6	3-1/4"	1-1/2"	1/2"
		CHC4X6	5-1/4"	3-1/2"	1"
		CHC7X6	8-3/4"	7"	4"
		CHC11X6	12-3/4"	11"	4"

9" TRIMMABLE DISTINCTION CROSSHEAD

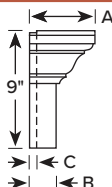

CROSSHEAD				
		Part Number	Overall Width	
		CHT36X9	36"	
		CHT48X9	48"	
		CHT144X9	144-3/8"	

END CAPS*					
		Part Number	Overall Width (A)	Width (B)	Rabbet Width (C)
		CHC2X9	4-1/4"	1-1/2"	1/2"
		CHC4X9	6-1/4"	3-1/2"	1"
		CHC7X9	9-3/4"	7"	4"
		CHC11X9	13-3/4"	11"	4"



6" TRIMMABLE CRAFTSMAN STEP CROSSHEAD

CROSSHEAD			
	Part Number	Overall Width	Height
	CHCST36X6	36"	6-1/4"
	CHCST48X6	48"	6-1/4"
	CHCST144X6	144-3/8"	6-1/4"

8" TRIMMABLE CRAFTSMAN STEP CROSSHEAD

CROSSHEAD			
	Part Number	Overall Width	Height
	CHCST36X8	36"	8-1/4"
	CHCST48X8	48"	8-1/4"
	CHCST144X8	144-3/8"	8-1/4"

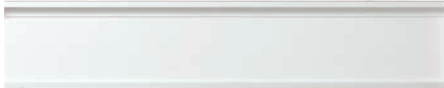
9" TRIMMABLE CRAFTSMAN COVE CROSSHEAD

CROSSHEAD			
	Part Number	Overall Width	
	CHCCT36X9BT	36"	
	CHCCT48X9BT	48"	
	CHCCT144X9BT	144"	

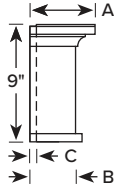
END CAPS*				
	Part Number	Overall Width (A)	Width (B)	Rabbet Width (C)
	CHCCC4X9BT-5	5"	3-1/2"	1/2"
	CHCCC6X9BT-5	7"	5-1/2"	1/2"

* END CAPS OVERLAP THE TRIMMABLE CROSSHEAD. SOLD IN PAIRS.

WINDOW & DOOR TRIM



COMBINATION PEAKED CAP PEDIMENT

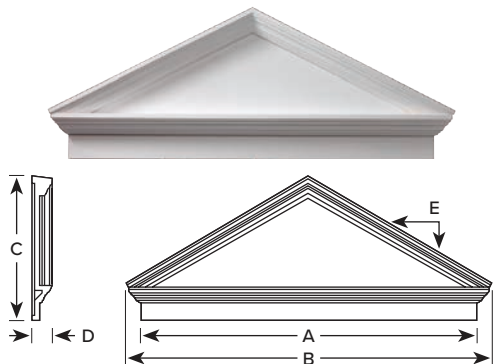

Part Number	Width (A)	Overall Width (B)	Overall Height (C)	Projection (D)	Pitch (E)	Breast Board Thickness
CPCP50	50"	54-1/2"	20-1/4"	3-1/8"	6/12	1"
CPCP54	54"	58-1/4"	21"	3-1/8"	6/12	1"

COMBINATION ACORN PEDIMENT

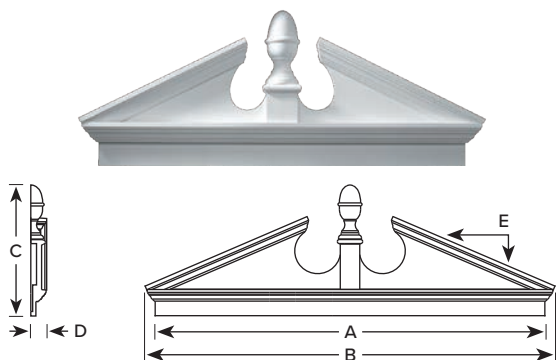

Part Number	Width (A)	Overall Width (B)	Overall Height (C)	Projection (D)	Pitch (E)
CAP50	50"	54-1/2"	21-1/8"	3-1/8"	6/12
CAP54	54"	58-1/2"	21-3/8"	3-1/8"	6/12
CAP75	75"	79-1/2"	25-1/8"	3-1/8"	6/12
CAP80	80"	84-7/16"	25-3/8"	3-1/8"	5-1/2/12
CAP85	85"	89-3/8"	28-3/4"	3-1/8"	5/12

SEGMENT SUNBURST

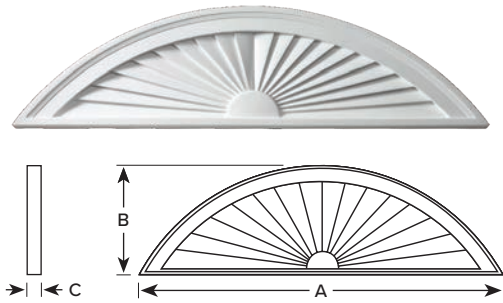

Part Number	Width (A)	Height (B)	Projection (C)
SWDH36X9	36"	9"	1-3/4"
SWDH48X13	48"	13"	1-3/4"
SWDH68X14	67-5/8"	14"	1-3/4"
SWDH72X14	72"	14"	1-3/4"
SWDH76X15	76"	15"	1-3/4"

HALF-ROUND SUNBURST

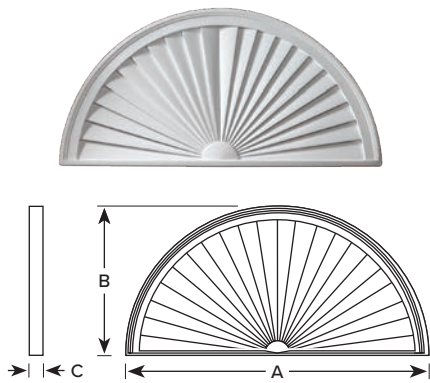

Part Number	Width (A)	Height (B)	Projection (C)
SWDH32X16	32"	16"	1-3/4"
SWDH33X17	33-5/8"	16-3/4"	1-3/4"
SWDH36X18	36"	18"	1-3/4"
SWDH37X19	37-5/8"	18-3/4"	1-3/4"
SWDH40X20	40"	20"	1-3/4"
SWDH42X21	42"	21"	1-3/4"
SWDH48X24	48"	24"	1-3/4"
SWDH60X30	60"	30"	1-3/4"
SWDH72X36	72"	36"	1-3/4"
SWDH76X38	76"	38"	1-3/4"

COMBINATION SUNBURST PEDIMENT

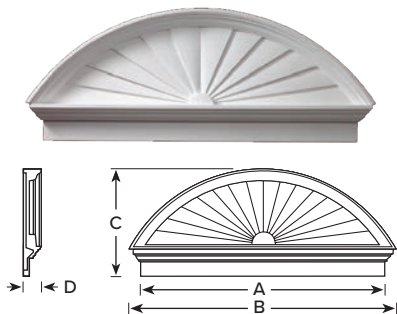

Part Number	Width (A)	Overall Width (B)	Height (C)	Projection (D)	Breast Board Thickness
CSP54	54"	58-1/2"	21-3/8"	3-1/8"	1"
CSP80	80"	84-5/8"	25-1/2"	3-1/8"	1"
CSP85	85"	89-1/2"	26-3/8"	3-1/8"	1"

WINDOW & DOOR TRIM

PLAIN PILASTER*

Part Number	Width (A)	Height (B)	Projection (C)	Plinth Block Height (D)
MOULDED WITH PLINTH				

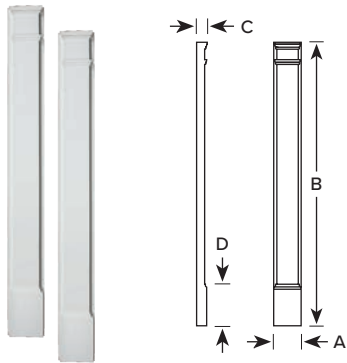

PIL5X90P	5-1/4"	90"	1-5/8"	10-1/8"
PIL7X90P	7"	90"	2-1/2"	13-1/4"
PIL8X90P	8"	90"	2-1/2"	13-1/4"

TWO-PIECE ADJUSTABLE				
-----------------------------	--	--	--	--

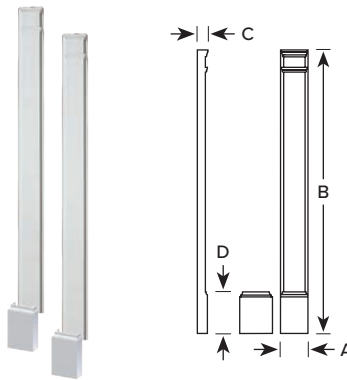

PIL5X108P	5-1/4"	108"	1-5/8"	10"
PIL6X120P	6"	120"	2-1/2"	13-1/4"
PIL7X108P	7"	108"	2-1/2"	13"
PIL8X108P	8"	108"	2-5/8"	13"
PIL9X108P	9"	108"	3"	14-1/2"
PIL11X108P	11"	108"	3-1/2"	14-1/2"

DOUBLE PANEL PILASTER*

Part Number	Width (A)	Height (B)	Projection (C)	Plinth Block Height (D)
MOULDED WITH PLINTH				

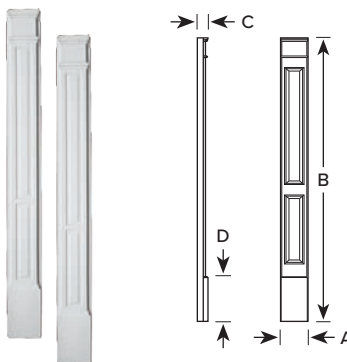

PIL5X90DP	5-1/4"	90"	1-5/8"	10-1/8"
PIL7X90DP	7"	90"	2-1/2"	13-1/4"
PIL11X108DP	11"	108"	3-1/2"	14-1/2"



FLUTED PILASTER*

	Part Number	Width (A)	Height (B)	Projection (C)	Plinth Block Height (D)
MOULDED WITH PLINTH					
	PIL4X86	4-1/2"	86"	1-5/8"	11"
	PIL4X90	4-1/2"	90"	1-5/8"	10"
	PIL5X82	5-1/4"	82"	1-3/4"	8"
	PIL5X90	5-1/4"	90"	1-3/4"	10-1/8"
	PIL6X90	6-1/4"	90"	2-1/2"	13-1/4"
	PIL7X90	7"	90"	2-1/2"	13-1/4"
	PIL9X90	9"	90"	3"	14-1/2"
	PIL11X90	11"	90"	3-1/2"	14-1/2"
TWO-PIECE ADJUSTABLE					
	PIL3X108	3-1/2"	108"	1-5/8"	10"
	PIL4X108	4-1/2"	108"	1-5/8"	10"
	PIL5X108	5-1/4"	108"	1-5/8"	10"
	PIL6X108	6-1/4"	108"	2-1/2"	13-1/4"
	PIL6X144	6-1/4"	144"	2-1/2"	13-1/4"
	PIL7X102	7"	102"	2-1/2"	13-1/4"
	PIL7X108	7"	108"	2-1/2"	13"
	PIL7X144	7"	144"	2-1/2"	13"
	PIL8X90	8"	90"	2-1/2"	13"
	PIL8X108	8"	108"	2-1/2"	13"
	PIL9X102	9"	102"	3"	14-1/2"
	PIL9X108	9"	108"	3"	14-1/2"
	PIL11X108	11"	108"	3-1/2"	14-1/2"
PIL11X120	11"	120"	3-1/2"	14-1/2"	

* ALL PILASTERS ARE SOLD IN PAIRS

WINDOW & DOOR TRIM

FLUTED ECONOMY PILASTER*

Part Number	Width (A)	Height (B)	Projection (C)	Plinth Block Height (D)
MOULDED WITH PLINTH				

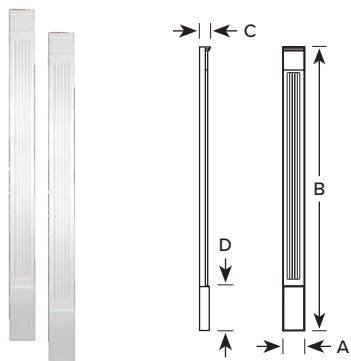

PIL5X90E	5-1/4"	90"	1-1/4"	14-1/4"
PIL7X90E	7"	90"	1-1/4"	14-1/4"

HALF ROUND ARCH TRIM

Part Number	Inside Width (A)	Inside Height (B)	Radius (C)
4F FLAT			

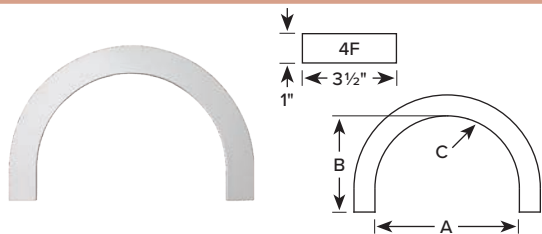

AR24X4F	24-1/8"	16-1/8"	12-1/8"
AR36X4F	36"	22"	18"
AR48X4F	48"	28"	24"
AR72X4F	72"	40"	36"

6F FLAT			
---------	--	--	--

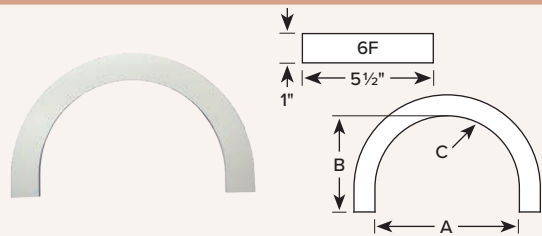

AR36X6F	36"	22"	18"
---------	-----	-----	-----

OVAL TRIM

Part Number	Inside Width (A)	Inside Height (B)	Projection (C)	Trim Width (D)
4F FLAT				

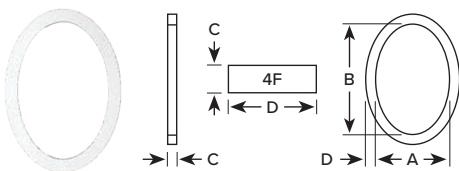

OV24X36X4F	24-1/8"	36-1/8"	1"	3-1/2"
------------	---------	---------	----	--------

WINDOW PANEL

Part Number	Overall Width (A)	Panel Width (B)	Overall Height (C)	Panel Height (D)	Border Width (E)	Border Height (F)
WDP36X18	36"	28"	18"	10"	4"	4"

The diagram shows a rectangular window panel with a double border. Dimension A is the overall width, B is the panel width, C is the overall height, D is the panel height, E is the border width, and F is the border height. A 1 1/8 inch offset is indicated on the right side.

DORMER TRIM SYSTEM

Part Number	Width (A)	Overall Width (B)	Overall Height (C)	Projection (D)
SIDE TRIM SET				
DMST7X69	6-3/4"	—	68-5/8"	1-1/2"
RETURN				
DMR457-10	—	—	—	—

The Side Trim Set diagram shows a vertical trim piece with dimensions A (width), B (overall width), C (overall height), and D (projection). The Return diagram shows a horizontal trim piece with dimensions A (width), B (overall width), C (overall height), and D (projection). Specific dimensions for the Return include 3 1/2" for the top width, 4 5/16" for the height, 3/4" for the bottom width, and 120" for the overall length.



WINDOW & DOOR TRIM

PLAIN DOOR SURROUND KITS*

Part Number	SL Width	Pilaster	Pilaster Width	Crosshead	Crosshead Width	Keystone	Door Unit Width Dimensions Range (A)	Outside Dimension of DSK (B)	Crosshead Can Be Trimmed
SINGLE DOOR									
WITH KEYSTONE									
DSKS05P516K	–	PIL5X108P	5"	WCH51X6	51"	K6M	Up to 41-1/2"	51"	YES
DSKS07P569K	–	PIL7X108P	7"	WCH56X9	56"	K9M	Up to 42"	56"	YES
DSKS08P589K	–	PIL8X108P	8"	WCH58X9	58"	K9M	Up to 42"	58"	YES
WITHOUT KEYSTONE									
DSKS05P516	–	PIL5X108P	5"	WCH51X6	51"	–	37-1/2" - 40-1/2"	51"	NO
DSKS07P569	–	PIL7X108P	7"	WCH56X9	56"	–	40"- 42"	56"	NO
DSKS08P589	–	PIL8X108P	8"	WCH58X9	58"	–	40"- 42"	58"	NO
SINGLE DOOR ONE SIDELITE									
WITH KEYSTONE									
DSKS105P646K	10"	PIL5X108P	5"	WCH64X6	64"	K6M	Up to 53-1/2"	64"	YES
DSKS107P679K	10"	PIL7X108P	7"	WCH67X9	67"	K9M	Up to 53"	67"	YES
DSKS108P699K	10"	PIL8X108P	8"	WCH69X9	69"	K9M	Up to 53"	69"	YES
DSKS105P646K	12"	PIL5X108P	5"	WCH64X6	64"	K6M	Up to 53-1/2"	64"	YES
DSKS107P689K	12"	PIL7X108P	7"	WCH68X9	68"	K9M	Up to 54"	68"	YES
DSKS108P709K	12"	PIL8X108P	8"	WCH70X9	70"	K9M	Up to 54"	70"	YES
DSKS105P666K	14"	PIL5X108P	5"	WCH66X6	66"	K6M	Up to 55-1/2"	66"	YES
DSKS17P709K	14"	PIL7X108P	7"	WCH70X9	70"	K9M	Up to 56"	70"	YES
DSKS18P729K	14"	PIL8X108P	8"	WCH72X9	72"	K9M	Up to 56"	72"	YES
WITHOUT KEYSTONE									
DSKS107P679	10"	PIL7X108P	7"	WCH67X9	67"	–	51"- 53"	67"	NO
DSKS108P699	10"	PIL8X108P	8"	WCH69X9	69"	–	51"- 53"	69"	NO
DSKS105P646	12"	PIL5X108P	5"	WCH64X6	64"	–	51-1/2" - 53-1/2"	64"	NO
DSKS107P689	12"	PIL7X108P	7"	WCH68X9	68"	–	52"- 54"	68"	NO
DSKS108P709	12"	PIL8X108P	8"	WCH70X9	70"	–	52"- 54"	70"	NO
DSKS105P666	14"	PIL5X108P	5"	WCH66X6	66"	–	53-1/2" - 55-1/2"	66"	NO
DSKS17P709	14"	PIL7X108P	7"	WCH70X9	70"	–	54"- 56"	70"	NO
DSKS18P729	14"	PIL8X108P	8"	WCH72X9	72"	–	54"- 56"	72"	NO

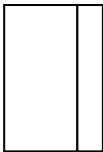

OR



PLAIN DOOR SURROUND KITS* (CONTINUED)

Part Number	SL Width	Pilaster	Pilaster Width	Crosshead	Crosshead Width	Keystone	Door Unit Width Dimensions Range (A)	Outside Dimension of DSK (B)	Crosshead Can Be Trimmed
SINGLE DOOR TWO SIDELITES									
WITH KEYSTONE									
DSKS205P746K	10"	PIL5X108P	5"	WCH74X6	74"	K6M	Up to 63-1/2"	74"	YES
DSKS207P779K	10"	PIL7X108P	7"	WCH77X9	77"	K9M	Up to 63"	77"	YES
DSKS208P809K	10"	PIL8X108P	8"	WCH80X9	80"	K9M	Up to 64"	80"	YES
DSKS205P786K	12"	PIL5X108P	5"	WCH78X6	78"	K6M	Up to 67-1/2"	78"	YES
DSKS207P819K	12"	PIL7X108P	7"	WCH81X9	81"	K9M	Up to 67"	81"	YES
DSKS208P849K	12"	PIL8X108P	8"	WCH84X9	84"	K9M	Up to 68"	84"	YES
DSKS25P846K	14"	PIL5X108P	5"	WCH84X6	84"	K6M	Up to 73-1/2"	84"	YES
DSKS27P869K	14"	PIL7X108P	7"	WCH86X9	86"	K9M	Up to 72"	86"	YES
DSKS28P889K	14"	PIL8X108P	8"	WCH88X9	88"	K9M	Up to 72"	88"	YES
WITHOUT KEYSTONE									
DSKS205P746	10"	PIL5X108P	5"	WCH74X6	74"	–	61-1/2" - 63-1/2"	74"	NO
DSKS207P779	10"	PIL7X108P	7"	WCH77X9	77"	–	61" - 63"	77"	NO
DSKS208P809	10"	PIL8X108P	8"	WCH80X9	80"	–	62" - 64"	80"	NO
DSKS205P786	12"	PIL5X108P	5"	WCH78X6	78"	–	65-1/2" - 67-1/2"	78"	NO
DSKS207P819	12"	PIL7X108P	7"	WCH81X9	81"	–	65" - 67"	81"	NO
DSKS208P849	12"	PIL8X108P	8"	WCH84X9	84"	–	66" - 68"	84"	NO
DSKS27P869	14"	PIL7X108P	7"	WCH86X9	86"	–	70" - 72"	86"	NO
DSKS28P889	14"	PIL8X108P	8"	WCH88X9	88"	–	70" - 72"	88"	NO
DOUBLE DOOR									
WITH KEYSTONE									
DSKD05P966K	–	PIL5X108P	5"	WCH96X6	96"	K6M	Up to 85-1/2"	96"	YES
DSKD07P939K	–	PIL7X108P	7"	WCH93X9	93"	K9M	Up to 79"	93"	YES
DSKD08P969K	–	PIL8X108P	8"	WCH96X9	96"	K9M	Up to 80"	96"	YES
WITHOUT KEYSTONE									
DSKD07P939	–	PIL7X108P	7"	WCH93X9	93"	–	77" - 79"	93"	NO

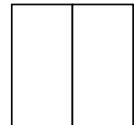
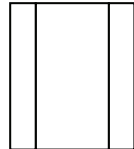

* DOOR SURROUND KITS CONSIST OF TWO PILASTERS AND THE CLASSIC CROSSHEAD.

WINDOW & DOOR TRIM

FLUTED DOOR SURROUND KITS*

Part Number	SL Width	Pilaster	Pilaster Width	Crosshead	Crosshead Width	Keystone	Door Unit Width Dimensions Range (A)	Outside Dimension of DSK (B)	Crosshead Can Be Trimmed
SINGLE DOOR									
WITH KEYSTONE									
DSKS05F516K	–	PIL5X108	5"	WCH51X6	51"	K6M	Up to 40-1/2"	51"	YES
DSKS07F569K	–	PIL7X108	7"	WCH56X9	56"	K9M	Up to 42"	56"	YES
DSKS08F589K	–	PIL8X108	8"	WCH58X9	58"	K9M	Up to 42"	58"	YES
WITHOUT KEYSTONE									
DSKS05F516	–	PIL5X108	5"	WCH51X6	51"	–	37-1/2" - 40-1/2"	51"	NO
DSKS07F569	–	PIL7X108	7"	WCH56X9	56"	–	40"- 42"	56"	NO
DSKS08F589	–	PIL8X108	8"	WCH58X9	58"	–	40"- 42"	58"	NO
SINGLE DOOR ONE SIDELITE									
WITH KEYSTONE									
DSKS105F646K	10"	PIL5X108	5"	WCH64X6	64"	K6M	Up to 53-1/2"	64"	YES
DSKS107F679K	10"	PIL7X108	7"	WCH67X9	67"	K9M	Up to 53"	67"	YES
DSKS108F699K	10"	PIL8X108	8"	WCH69X9	69"	K9M	Up to 53"	69"	YES
DSKS105F646K	12"	PIL5X108	5"	WCH64X6	64"	K6M	Up to 53-1/2"	64"	YES
DSKS107F689K	12"	PIL7X108	7"	WCH68X9	68"	K9M	Up to 54"	68"	YES
DSKS108F709K	12"	PIL8X108	8"	WCH70X9	70"	K9M	Up to 54"	70"	YES
DSKS105F666K	14"	PIL5X108	5"	WCH66X6	66"	K6M	Up to 55-1/2"	66"	YES
DSKS17F709K	14"	PIL7X108	7"	WCH70X9	70"	K9M	Up to 56"	70"	YES
DSKS18F729K	14"	PIL8X108	8"	WCH72X9	72"	K9M	Up to 56"	72"	YES
WITHOUT KEYSTONE									
DSKS107F679	10"	PIL7X108	7"	WCH67X9	67"	–	51"- 53"	67"	NO
DSKS108F699	10"	PIL8X108	8"	WCH69X9	69"	–	51"- 53"	69"	NO
DSKS105F646	12"	PIL5X108	5"	WCH64X6	64"	–	51-1/2" - 53-1/2"	64"	NO
DSKS107F689	12"	PIL7X108	7"	WCH68X9	68"	–	52"- 54"	68"	NO
DSKS108F709	12"	PIL8X108	8"	WCH70X9	70"	–	52"- 54"	70"	NO
DSKS105F666	14"	PIL5X108	5"	WCH66X6	66"	–	53-1/2" - 55-1/2"	66"	NO
DSKS17F709	14"	PIL7X108	7"	WCH70X9	70"	–	54"- 56"	70"	NO
DSKS18F729	14"	PIL8X108	8"	WCH72X9	72"	–	54"- 56"	72"	NO



OR



FLUTED DOOR SURROUND KITS* (CONTINUED)

Part Number	SL Width	Pilaster	Pilaster Width	Crosshead	Crosshead Width	Keystone	Door Unit Width Dimensions Range (A)	Outside Dimension of DSK (B)	Crosshead Can Be Trimmed
SINGLE DOOR TWO SIDELITES									
WITH KEYSTONE									
DSKS205F746K	10"	PIL5X108	5"	WCH74X6	74"	K6M	Up to 63-1/2"	74"	YES
DSKS207F779K	10"	PIL7X108	7"	WCH77X9	77"	K9M	Up to 63"	77"	YES
DSKS208F809K	10"	PIL8X108	8"	WCH80X9	80"	K9M	Up to 64"	80"	YES
DSKS205F786K	12"	PIL5X108	5"	WCH78X6	78"	K6M	Up to 67-1/2"	78"	YES
DSKS207F819K	12"	PIL7X108	7"	WCH81X9	81"	K9M	Up to 67"	81"	YES
DSKS208F849K	12"	PIL8X108	8"	WCH84X9	84"	K9M	Up to 68"	84"	YES
DSKS25F846K	14"	PIL5X108	5"	WCH84X6	84"	K6M	Up to 73-1/2"	84"	YES
DSKS27F869K	14"	PIL7X108	7"	WCH86X9	86"	K9M	Up to 72"	86"	YES
DSKS28F889K	14"	PIL8X108	8"	WCH88X9	88"	K9M	Up to 72"	88"	YES
WITHOUT KEYSTONE									
DSKS205F746	10"	PIL5X108	5"	WCH74X6	74"	–	61-1/2" - 63-1/2"	74"	NO
DSKS207F779	10"	PIL7X108	7"	WCH77X9	77"	–	61" - 63"	77"	NO
DSKS208F809	10"	PIL8X108	8"	WCH80X9	80"	–	62" - 64"	80"	NO
DSKS205F786	12"	PIL5X108	5"	WCH78X6	78"	–	65-1/2" - 67-1/2"	78"	NO
DSKS207F819	12"	PIL7X108	7"	WCH81X9	81"	–	65" - 67"	81"	NO
DSKS208F849	12"	PIL8X108	8"	WCH84X9	84"	–	66" - 68"	84"	NO
DSKS27F869	14"	PIL7X108	7"	WCH86X9	86"	–	70" - 72"	86"	NO
DSKS28F889	14"	PIL8X108	8"	WCH88X9	88"	–	70" - 72"	88"	NO
DOUBLE DOOR									
WITH KEYSTONE									
DSKD05F966K	–	PIL5X108	5"	WCH96X6	96"	K6M	Up to 85-1/2"	96"	YES
DSKD07F939K	–	PIL7X108	7"	WCH93X9	93"	K9M	Up to 79"	93"	YES
DSKD08F969K	–	PIL8X108	8"	WCH96X9	96"	K9M	Up to 80"	96"	YES
WITHOUT KEYSTONE									
DSKD07F939	–	PIL7X108	7"	WCH93X9	93"	–	77" - 79"	93"	NO

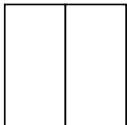
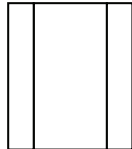

* DOOR SURROUND KITS CONSIST OF TWO PILASTERS AND THE CLASSIC CROSSHEAD.



SHUTTERS

BOARD & BATTEN - ROUGH SAWN CEDAR

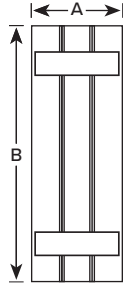

	14" 3 BOARD, 2 BATTEN		18" 3 BOARD, 2 BATTEN		
SH3PC14X35RS	14"	35"	SH3PC18X35RS	18"	35"
SH3PC14X39RS	14"	39"	SH3PC18X39RS	18"	39"
SH3PC14X43RS	14"	43"	SH3PC18X43RS	18"	43"
SH3PC14X47RS	14"	47"	SH3PC18X47RS	18"	47"
SH3PC14X51RS	14"	51"	SH3PC18X51RS	18"	51"
SH3PC14X55RS	14"	55"	SH3PC18X55RS	18"	55"
SH3PC14X59RS	14"	59"	SH3PC18X59RS	18"	59"
SH3PC14X63RS	14"	63"	SH3PC18X63RS	18"	63"
SH3PC14X67RS	14"	67"	SH3PC18X67RS	18"	67"
SH3PC14X71RS	14"	71"	SH3PC18X71RS	18"	71"

FLAT SHAKER-STYLE

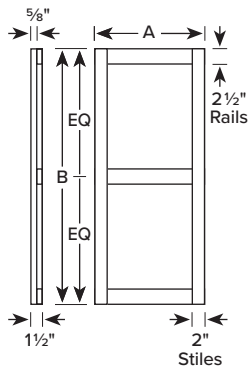

	16"		18"		
SH2FP16X35	16"	35"	SH2FP18X35	18"	35"
SH2FP16X39	16"	39"	SH2FP18X39	18"	39"
SH2FP16X43	16"	43"	SH2FP18X43	18"	43"
SH2FP16X47	16"	47"	SH2FP18X47	18"	47"
SH2FP16X51	16"	51"	SH2FP18X51	18"	51"
SH2FP16X55	16"	55"	SH2FP18X55	18"	55"
SH2FP16X59	16"	59"	SH2FP18X59	18"	59"
SH2FP16X63	16"	63"	SH2FP18X63	18"	63"
SH2FP16X67	16"	67"	SH2FP18X67	18"	67"
SH2FP16X71	16"	71"	SH2FP18X71	18"	71"

MODERN FARMHOUSE SHAKER-STYLE

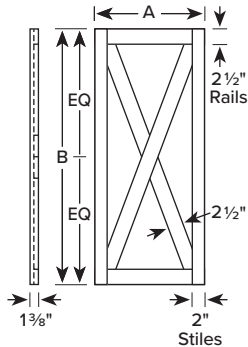

Part Number	Overall Width (A)	Overall Height (B)
SHMFH18X48	18"	48"
SHMFH18X60	18"	60"
SHMFH18X72	18"	72"

MOULDINGS

IT'S ALL IN THE DETAILS.

Discover a variety of options, ranging from simple to ornate. Fypon's portfolio of beautiful, inspired styles is available in a range of sizes and combinations, ideal for adding character to any home.



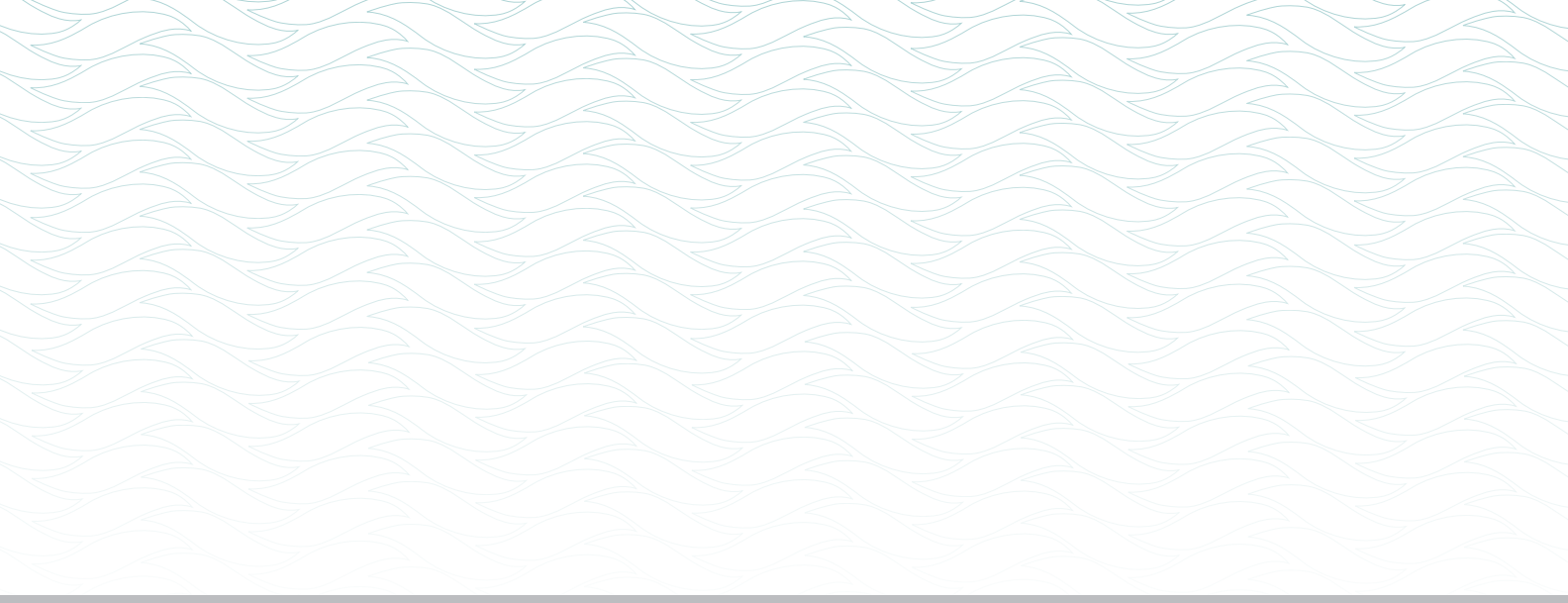

Creating a distinctive look is important. Crown moulding and chair rail create the perfect classic look for a home, with easy installation using standard woodworking tools. All Fypon polyurethane products can be used on the interior or exterior of the home. Each piece has a consistent quality and finish, which requires no additional priming. Once installed, they can be painted or faux finished.

The products in this section of the catalog are organized by moulding type. You can find a variety of products to match the aesthetics of almost any application conveniently grouped together. Where applicable, groups of mouldings are further sorted by height, from smallest to largest. Rosettes or plinth blocks help make moulding installations quick and easy by eliminating the need for patching to create smooth seams. A urethane-based adhesive must be used on all joint surfaces. For more information, please see page 71.

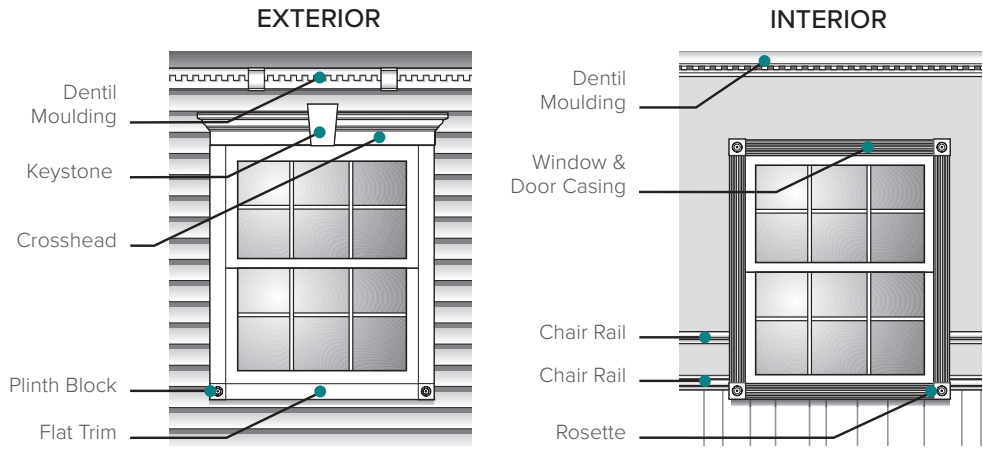







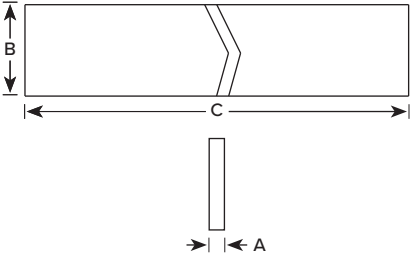



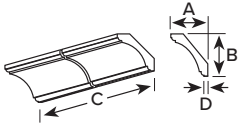

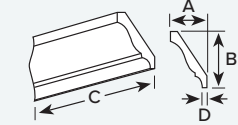

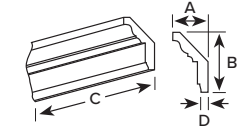

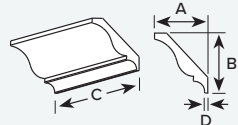
MOULDINGS

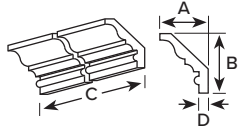

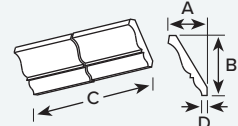
SMOOTH FLAT TRIM

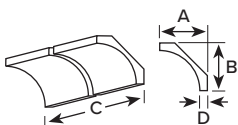

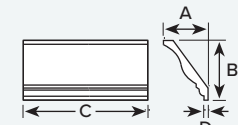

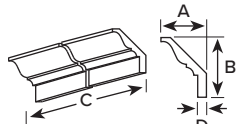
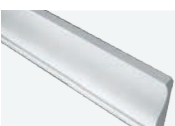
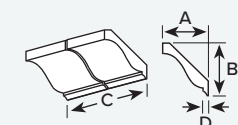





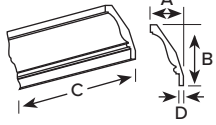

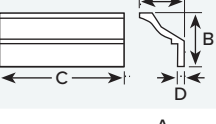

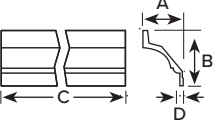
	Part Number	Thickness (A)	Width (B)	Length (C)	Arch Moulding Match	Plinth Block/Rosette
 	FLT122-16	3/4"	3-1/2"	16'	—	—
	FLT110-16	3/4"	5-1/2"	16'	—	PB6X6
	FLT109-12	3/4"	6"	12'	—	—
	FLT186-16	3/4"	7-1/4"	16'	—	—
	FLT113-8	3/4"	8"	8'	—	—
	FLT118-8	3/4"	10"	8'	—	—
	FLT152-8	1"	3-1/2"	8'	4F	PB4X4
	FLT152-12	1"	3-1/2"	12'	4F	PB4X4
	FLT153-12	1"	4"	12'	—	—
	FLT159-8	1"	5-1/2"	8'	6F	PB6X6
	FLT159-16	1"	5-1/2"	16'	6F	PB6X6
	FLT162-8	1"	7-1/2"	8'	—	—
	FLT170-12	1"	9-1/2"	12'	—	—
	FLT172-16	1"	11-1/2"	16'	—	—
	FLT183-12	1-1/2"	5-1/2"	12'	—	—

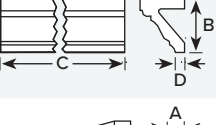
CROWN MOULDING

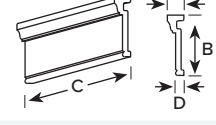
		Part Number	Projection (A)	Height (B)	Length (C)	Bottom Thickness (D)	Unattached Accessories
		MLD593-16	2-1/2"	2-1/2"	16'	1/4"	—
		MLD452-12	2"	3"	12'	1/4"	—
		MLD552-12	2-1/8"	3-1/2"	12'	3/8"	—
		MLD454-12	3-5/8"	4-1/8"	12'	1/4"	—
		MLD572-16	3-1/4"	4-1/4"	16'	5/8"	—
		MLD456-16	2-3/4"	4-3/8"	16'	1/4"	—
		MLD584-16	4-3/4"	4-3/4"	16'	3/4"	—
		MLD453-16	4-3/4"	6-3/4"	16'	1/2"	—
		MLD569-12	5-3/4"	7-1/2"	12'	1-1/8"	—
		MLD449-16	7-1/8"	8-1/2"	16'	1/8"	—

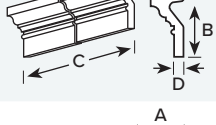
MOULDINGS

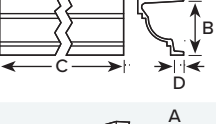









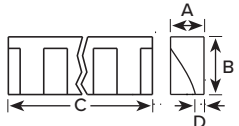

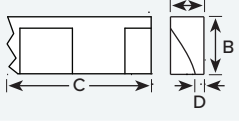

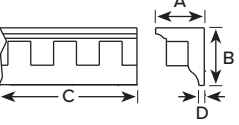

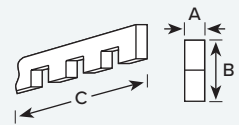

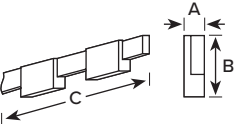

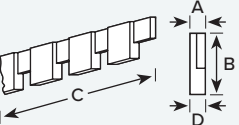
CROWN MOULDING (CONTINUED)

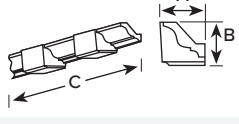
		Part Number	Projection (A)	Height (B)	Length (C)	Bottom Thickness (D)	Unattached Accessories
		MLD555-12	5-1/4"	10-3/4"	12'	7/8"	—
		MLD371-16	6-1/2"	11"	16'	1"	—
		MLD585-12	10-1/2"	17"	12'	7/8"	—
LIP MOULDING							
		MLD240-8	3-1/4"	4"	8'	3/4"	DTLB6X4X6
		MLD226-16	1-1/2"	5-1/2"	16'	3/4"	—
		MLD527-16	3-1/2"	7-5/8"	16'	1"	—
		MLD520-16	6-1/8"	8-1/8"	16'	1-7/8"	—
		MLD505-8 Massive Fascia	3-3/8"	13"	8'	1"	—

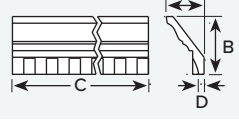

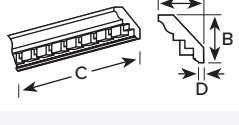

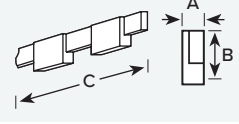
MOULDINGS

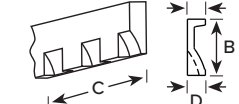
DENTIL MOULDING

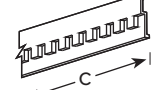

		Part Number	Projection (A)	Height (B)	Length (C)	Bottom Thickness (D)	Design Repeat	Tooth and Space
		MLD303-5	5/8"	1-1/4"	5'	1/4"	1-1/2"	3/4" Tooth 3/4" Space
		MLD304-8	5/8"	1-1/4"	8'	1/4"	2-1/2"	1-1/4" Tooth 1-1/4" Space
		MLD313-8	2-1/4"	2-3/8"	8'	1/4"	2"	1" Tooth 1" Space
		MLD354-12	1"	3-1/8"	12' 2-1/4"	—	3-1/4"	1-5/8" Tooth 1-5/8" Space
		MLD351-8	1-1/4"	3-1/4"	8' 2"	—	7"	3-1/2" Tooth 3-1/2" Space
		MLD350-8	7/8"	3-1/2"	8' 3-3/4"	1/2"	3-3/4"	2-3/16" Tooth 1-1/2" Space
		MLD360-8	3-1/2"	3-3/4"	8'	—	8"	3-3/4" Tooth 4-3/8" Space
		MLD404-16	2-1/2"	3-7/8"	16'	1/4"	1-1/2"	3/4" Tooth 3/4" Space
		MLD406-16	3-3/8"	4"	16'	3/8"	2"	1-1/4" Tooth 3/4" Space
		MLD353-8	1-1/4"	4-1/2"	8' 1/4"	—	8-3/4"	4-3/8" Tooth 4-3/8" Space
		MLD310-8	1-1/4"	4-1/2"	8'	1/2"	3"	1-1/2" Tooth 1-1/2" Space
		MLD310-12	1-1/4"	4-1/2"	12'	1/2"	3"	
		MLD310-16	1-1/4"	4-1/2"	16'	1/2"	3"	

DENTIL MOULDING (CONTINUED)

			Part Number	Projection (A)	Height (B)	Length (C)	Bottom Thickness (D)	Design Repeat	Tooth and Space
			MLD332-8	1-5/8"	5"	8'	7/8"	4"	2" Tooth 2" Space
			MLD365-16	5"	5"	16'	3/8"	4-5/8"	2-1/4" Tooth 2-3/8" Space
			MLD320-12	1-5/8"	5-3/4"	12'	3/8"	4-1/2"	2-3/8" Tooth
			MLD320-16	1-5/8"	5-3/4"	16' 1-1/2"	3/8"	4-1/2"	2-1/4" Space
			MLD335-12	3-3/8"	6-1/8"	12'	1/2"	7-1/4"	3-1/8" Tooth 4-1/4" Space
			MLD410-12	3-1/4"	6-7/8"	12'	1/2"	3"	1-1/2" Tooth 1-1/2" Space
			MLD330-12	1-5/8"	7"	12'	7/8"	4"	2" Tooth 2" Space
			MLD411-16	4-1/2"	7"	16'	1/2"	3"	1-1/2" Tooth 1-1/2" Space
			MLD370-8	6-1/2"	7-1/2"	8'	1"	19-1/4"	4-3/4" Tooth 14-1/2" Space
			MLD430-12	5-3/4"	8"	12' 2-1/4"	1/4"	2-5/8"	1-3/4" Tooth 7/8" Space
			MLD362-16	5-1/8"	8-3/8"	16'	1-1/4"	4-1/2"	2" Tooth 2-1/2" Space
			MLD336-16	3-1/8"	9-3/8"	16' 1"	3/4"	5"	2-1/2" Tooth 2-1/2" Space



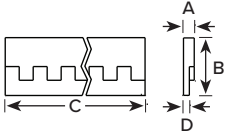
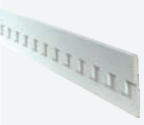
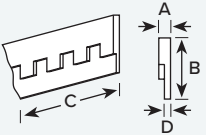

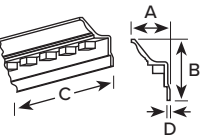





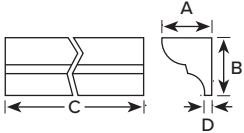

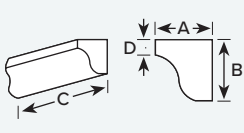

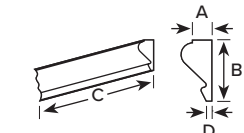
MOULDINGS

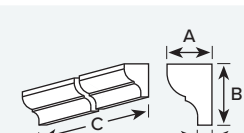
DENTIL MOULDING (CONTINUED)

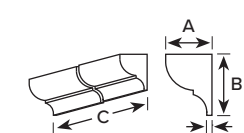
		Part Number	Projection (A)	Height (B)	Length (C)	Bottom Thickness (D)	Design Repeat	Tooth and Space
		MLD331-16	1-3/8"	9-1/2"	16' 1-1/2"	3/4"	4 1/2"	2-1/4" Tooth 2-1/4" Space
		MLD333-12	1-3/16"	11-1/2"	12' 4-1/2"	5/8"	5-1/2"	2-3/4" Tooth 2-3/4" Space
		MLD421-12	10"	14-1/2"	12'	3/4"	6"	2" Tooth 4" Space

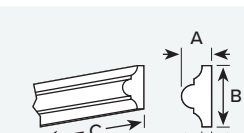



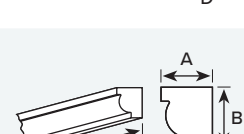

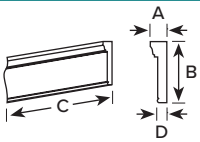

CAP

		Part Number	Projection (A)	Height (B)	Length (C)	Bottom Thickness (D)
		MLD626-8	1-1/8"	1-1/4"	8'	1/8"
		MLD601-12	1-1/4"	1-1/2"	12'	3/8"
		MLD612-12	3/4"	1-3/8"	12'	1/8"
		MLD634-16	1-3/8"	1-7/8"	16'	1/4"
		MLD649-16	1-1/2"	2-1/8"	16'	3/8"
		MLD611-12	1-1/8"	2-1/4"	12'	3/8"
		MLD610-8	1-1/2"	2-3/8"	8'	1/2"
		MLD613-12	2-3/8"	2-3/4"	12'	1"

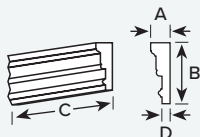

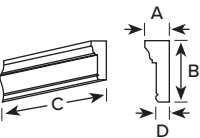

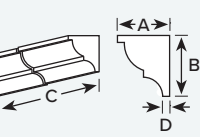
MOULDINGS

CHAIR RAIL

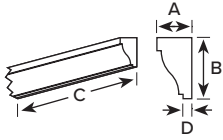

		Part Number	Projection (A)	Height (B)	Length (C)	Bottom Thickness (D)	Unattached Accessories
		MLD227-16	1-1/2"	9"	16'	3/4"	—
		MLD220-12	1-3/4"	5-1/2"	12'	3/4"	K6TM
		MLD220-16	1-3/4"	5-1/2"	16'	3/4"	K6TM
		MLD250-8	1-3/4"	4-1/2"	8'	1"	—
		MLD250-12	1-3/4"	4-1/2"	12'	1"	—
		MLD641-16	3-3/4"	4-3/8"	16'	1/2"	—

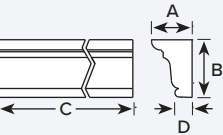

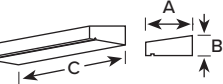
WINDOW AND DOOR

	Part Number	Projection (A)	Height (B)	Length (C)	Bottom Thickness (D)	Unattached Accessories
 	MLD231-12	1"	1-3/4"	12'	1/4"	—
 	MLD214-12	2"	2-7/8"	12'	3/4"	—
 	MLD710-10	3-1/2"	1-1/2" tapers to 1"	10'	—	—

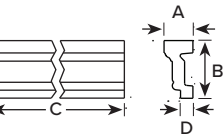
ASSORTED

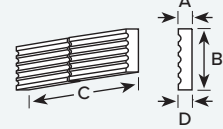
	Part Number	Projection (A)	Height (B)	Length (C)	Bottom Thickness (D)	Unattached Accessories
 	MLD215-12 4M Profile	1-3/4"	3-1/2"	12'	3/4"	K4TM KP4TM
 	MLD207-16 Fluted	1"	5-1/4"	16'	1"	PB6X6

MOULDING ACCESSORIES

PLINTH BLOCKS / ROSETTES

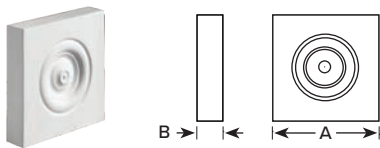

Part Number	Width (A)	Projection (B)
PB4X4	3-5/8"	1-1/8"
PB5X5	5-1/4"	1"
PB6X6	5-5/8"	1-1/8"

DECORATIVE MILLWORK

DISCOVER UNLIMITED POSSIBILITIES.

Fypon's collection of architecturally correct and historically accurate Decorative Millwork including Brackets, Rafter Tails, Beam Mantels, Dentil Blocks, and other products adds a refined look to both interior and exterior applications.





Decorative millwork is the perfect choice to add the finishing touches on interior and exterior applications. These low maintenance details are easy to install with no additional tools or special installation methods needed. Fypon decorative millwork is architecturally accurate and can be painted or stained to fit your needs. Fypon offers decorative brackets in a woodgrain or smooth texture or a smooth dentil block both in many sizes. Also available are rafter tails that will stand up to the elements!

The products in this section of the catalog are organized by product type. You can find a variety of products to match the aesthetics of almost any application conveniently grouped together. A urethane-based adhesive must be used on all joint surfaces. For more information, please see page 71.

DECORATIVE MILLWORK

SMOOTH BRACKETS

		Part Number	Projection (A)	Height (B)	Overall Width (C)
COVE/ARCH					
		BKT15X18X6	15"	18"	6"
		BKT19X24X4	18-5/8"	24"	4"
		BKT19X36X4	19"	36"	4"
		BKT20X24X5	20"	24"	5"
		BKT25X25	25"	25"	4"
		BKT28X30	28"	30"	3-1/2"
		BKT30X30	30"	30"	6"
		BKT36X36	36-1/8"	36-1/8"	6"
		BKT31X30X5	31"	30"	5"
		BKT19X31	19-1/2"	31-1/2"	7-1/4"
		BKT6X8	6"	8"	1-1/2"
		BKT8X8	8"	8"	2"
		BKT8X6	8"	6"	4"











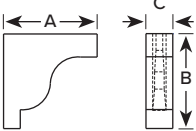

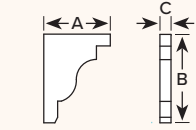

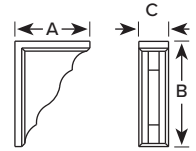

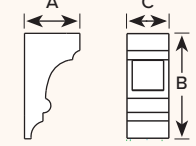

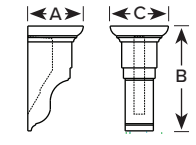

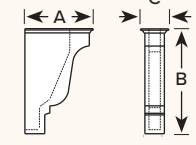
SMOOTH BRACKETS (CONTINUED)

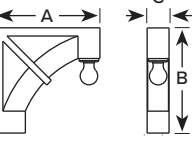
		Part Number	Projection (A)	Height (B)	Overall Width (C)
		BKT8X8X4	8"	8"	4-7/8"
		BKT10X10X9	10"	10"	9-1/8"
		BKT10X11	10-1/2"	11-1/4"	3"
		BKT7X11X3	7"	11"	3-1/2"
		BKT7X12X4	7-1/4"	12"	4"
		BKT10X12X4	10"	12"	4"
		BKT12X10 Recessed	12"	10-1/8"	7-1/4"

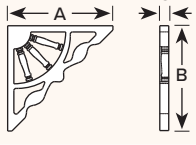
DECORATIVE MILLWORK

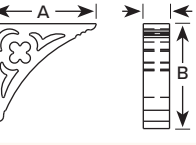
SMOOTH BRACKETS (CONTINUED)

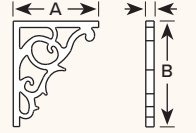
		Part Number	Projection (A)	Height (B)	Overall Width (C)
		BKT14X16	14"	15-3/4"	4"
		BKT18X24X3	18"	24"	3"
DECORATIVE					
		BKT11X15	11"	15"	3"
		BKT5X10	5-1/4"	10"	4"
		BKT8X15	7-7/8"	14-7/8"	8-1/4"
		BKT11X16	10-1/2"	16-1/4"	4-3/8"
		BKT24X24X5	24"	24"	5"
		BKT12X12GP	12"	12"	1"
		BKT22X21	21-3/4"	21-1/2"	3"
		BKT10X12	10-1/8"	12-1/2"	1"



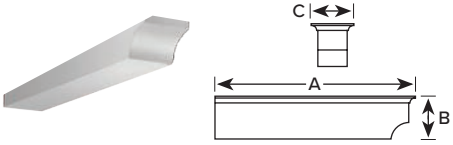
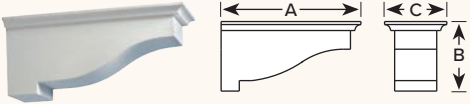
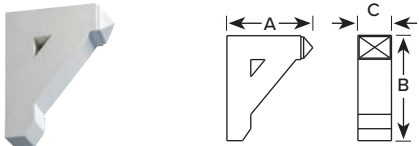
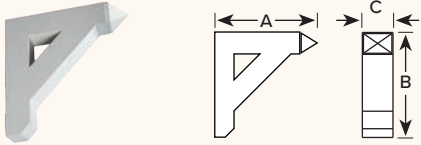
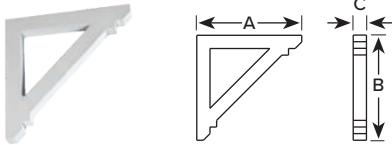
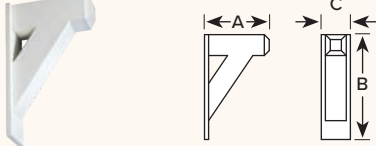











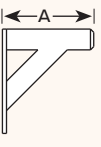
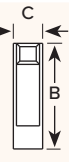

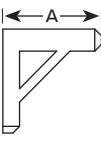
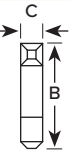

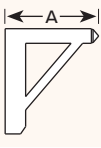
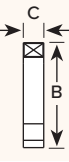

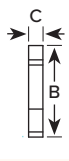
SMOOTH BRACKETS (CONTINUED)

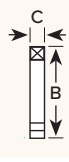
	Part Number	Projection (A)	Height (B)	Overall Width (C)
	BKT5X4	20-1/2"	4-3/8"	4-3/8"
	BKT13X6	13-1/4"	5-3/4"	5-7/8"
FLAT				
	BKT9X11	9"	11"	3-1/2"
	BKT12X12X4	12"	12"	3-1/2"
	BKT18X18X4	18"	18"	3-1/2"
	BKT16X16	15-7/8"	15-7/8"	2"
	BKT10X16X4	9-7/8"	16"	4-1/2"

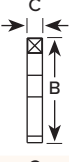

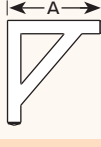
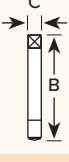

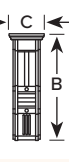

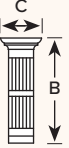

SMOOTH BRACKETS (CONTINUED)

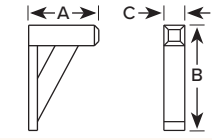

			Part Number	Projection (A)	Height (B)	Overall Width (C)
			BKT12X16	11-1/2"	16"	3"
			BKT14X16X4	14"	16"	4-1/2"
			BKT17X17	16-1/2"	16-1/2"	3-1/2"
			BKT16X18X3	16"	18"	3-1/2"
			BKT11X20	11"	20-1/2"	8"
			BKT12X24X3	12"	24"	3-1/2"
			BKT18X24X4	18"	24"	3-1/2"
			BKT25X27	25"	27-1/2"	3-1/2"
			BKT36X36X4	36"	36"	4"
ORNATE						
			BKT11x20x6	11"	20"	6-1/2"
			BKT11X20X8	11"	20-1/2"	8"

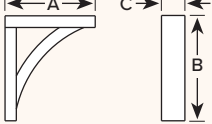
DECORATIVE MILLWORK

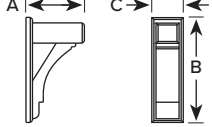



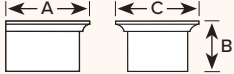
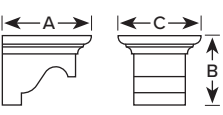
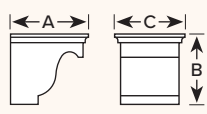





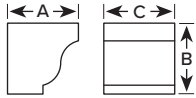

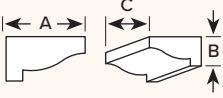

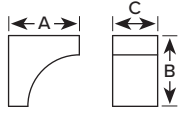

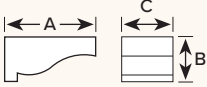

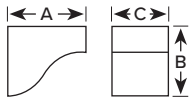
WOODGRAIN BRACKETS

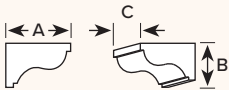
	Part Number	Projection (A)	Height (B)	Overall Width (C)
STANDARD WOODGRAIN				
 	BKT12X18X3X1S	12"	18"	3-1/2"
 	BKT16X18X4S	16"	18"	4"
 	BKT14X30X7.5S	13-1/2"	30"	7-1/2"

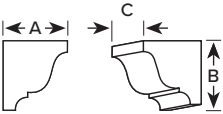
SMOOTH DENTIL BLOCKS

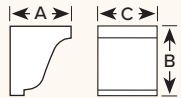
	Part Number	Projection (A)	Height (B)	Overall Width (C)
FLAT				
 	DTLB3X3X3	3-1/2"	3-1/2"	3-1/2"
DECORATIVE				
 	DTLB4X5X8	7-3/4"	3-3/8"	5"
 	DTLB6X6X9	9-3/8"	5-3/4"	5-1/2"
 	DTLB9X8X8	9"	8-1/8"	8-1/8"
 	DTLB4X4X7	7-1/4"	4-3/8"	5"
 	DTLB5X8	5-7/16"	8-1/4"	4-13/16"

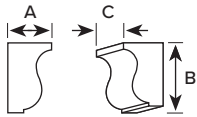
SMOOTH DENTIL BLOCKS

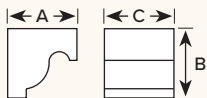
		Part Number	Projection (A)	Height (B)	Overall Width (C)
ASSORTED					
		DTLB4X4X4	4"	4"	4"
		DTLB4X6X7	7-1/8"	4"	6"
		DTLB5X5X3	5-12"	5-1/2"	3-1/2"
		DTLB5X6X11	10-3/4"	5-1/4"	6"
		DTLB5X4X7	6-7/8"	5-3/8"	4-3/8"
		DTLB6X6X8	8"	5-3/8"	5-1/2"
		DTLB6X4X6	5-1/2"	6-1/8"	4-3/4"
		DTLB6X6X5	5-1/2"	6-1/4"	4-3/4"
		DTLB8X6X6	5-3/16"	8-1/8"	5-1/2"
		DTLB3X3X4	4-1/2"	3-3/4"	3-3/4"
		DTLB4X5X7	7-3/4"	4-1/4"	5-1/8"

DECORATIVE MILLWORK

WOODGRAIN KNEE BRACES

	Part Number	Projection (A)	Height (B)	Overall Width (C)
STANDARD WOODGRAIN				

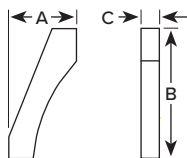

BKT12X24X3S

12"

24"

3-3/8"

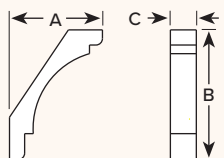

BKT22X30X6S

21-1/2"

30"

6"

SMOOTH KNEE BRACES

	Part Number	Projection (A)	Height (B)	Overall Width (C)
	BKT14X14	13-1/4"	13-1/4"	3-1/2"

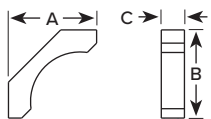

BKT14X14

13-1/4"

13-1/4"

3-1/2"

PORCH SPANDRELS

	Part Number	Length (A)	Height (B)	Projection (C)	Design Repeat (D)
	PRS48X8	48"	7-3/4"	1"	5-1/4"

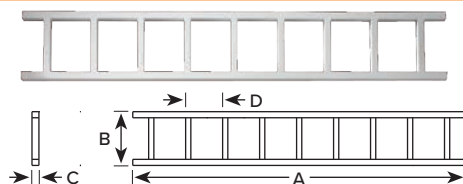

PRS48X8

48"

7-3/4"

1"

5-1/4"

FULL-ROUND FINIAL

	Part Number	Ball Diameter (A)	Height (B)	Base Diameter (C)
	B5X7	5-1/4"	6-3/4"	4-3/8"
	B6X8	5-7/8"	7-3/4"	5-7/8"
	B6X9	7"	9"	5-7/8"

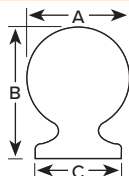

B5X7

5-1/4"

6-3/4"

4-3/8"

B6X8

5-7/8"

7-3/4"

5-7/8"

B6X9

7"

9"

5-7/8"



GABLE PEDIMENTS

	Part Number	Overall Width (A)	Overall Height (B)	Projection (C)	Pitch (D)
ARCHED STYLE					
	GPA70X35	70"	35"	3-1/4"	12/12
	GPA81X34	80-1/2"	33-1/2"	3-1/4"	10/12
	GPA86X32	85-1/4"	32-1/4"	3-1/4"	9/12
	GPA87X29	86-7/8"	29"	3-1/4"	8/12
FLAT STYLE					
	GPF66X33	66"	36-1/2"	1"	12/12
VICTORIAN STYLE					
	GP64X32	62"	32-1/4"	1"	12/12

DECORATIVE MILLWORK



RAFTER TAILS

	Part Number	Length (A)	Height (B)	Overall Width (C)
SCROLL PROFILE				
	BMRTSC4X6X24	24"	3-1/2"	5-1/2"
	BMRTSC4X8X24	24"	3-1/2"	7-1/2"
SLANT PROFILE				
	BMRTSL4X6X24	24"	3-1/2"	5-1/2"
	BMRTSL4X8X24	24"	3-1/2"	7-1/2"
STRAIGHT PROFILE				
	BMRTST4X6X24	24"	3-1/2"	5-1/2"
	BMRTST4X8X24	24"	3-1/2"	7-1/2"



BEAM MANTEL

	Part Number	Length (A)	Height (B)	Overall Width (C)
ELM - HAND HEWN				
	BMH6X8X60ELM-EC	60"	7-1/2"	5-1/2"
	BMH6X8X72ELM-EC	72"	7-1/2"	5-1/2"
	BMH8X10X60ELM-EC	60"	9-1/2"	7-1/2"
	BMH8X10X72ELM-EC	72"	9-1/2"	7-1/2"
CEDAR - ROUGH SAWN				
	BMR6X8X60CDR-EC	60"	7-1/2"	5-1/2"
	BMR6X8X72CDR-EC	72"	7-1/2"	5-1/2"
	BMR8X10X60CDR-EC	60"	9-1/2"	7-1/2"
	BMR8X10X72CDR-EC	72"	9-1/2"	7-1/2"

LOUVERS

HISTORIC STYLES FOR ANY HOME.

Fypon offers a diverse assortment of Louvers to complement most architectural home styles.





Fypon manufactures two types of louvers - decorative and functional. Decorative louvers have closed, non-ventilating slats that do not allow air to pass through. They are used for decorative purposes only, to accent exterior façade applications.

Functional louvers accent exterior applications, but also have open slats that allow for ventilation. The inside of the functional louver has a non-corrosive screen that helps keep insects out, while allowing airflow between the slats. In addition, accessory pieces such as flat trim and keystones add style and beauty, and are available for most louver styles.

If you are ordering a functional louver, you should order a louver that is approximately 2" larger than your rough opening on all sides. This will allow you to attach the louver to the substrate through the brickmould edge.

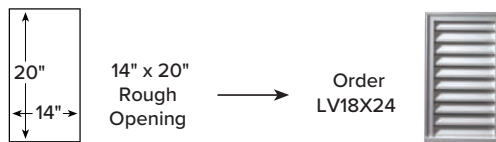

The products in this section of the catalog are organized by louver style followed by matching trim. Where applicable, matching keystones are referenced for each louver and trim piece. A urethane-based adhesive must be used on all joint surfaces. For more information, please see page 71.

Louvers with a flat trim will use a flat keystone profile.

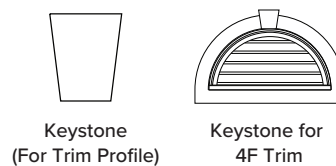

Louvers with a brickmould trim or with no trim will use a brickmould keystone profile.

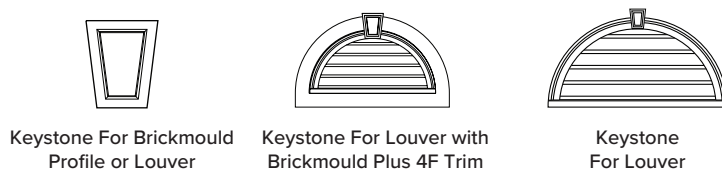

LOUVERS

CATHEDRAL LOUVER

BRICKMOULD STYLE

Part Number Inside Width (A) Inside Height (B) Trim Width (C) Projection (D)

DECORATIVE (NON-VENTING UNIT)

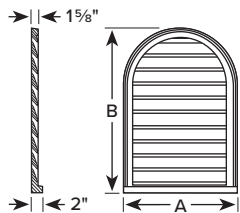

CLV12X24	12"	24"	—	—
CLV18X30	18"	30"	—	—
CLV22X31	22"	31-1/2"	—	—



EYEBROW LOUVER

BRICKMOULD STYLE

Part Number Width (A) Overall Height (B) Shoulder Height Radius

DECORATIVE (NON-VENTING UNIT)

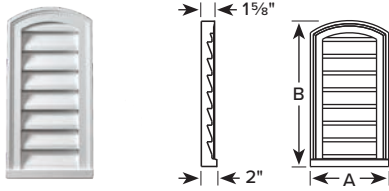

EBLV18X30	18"	30"	27-1/4"	16"
-----------	-----	-----	---------	-----

VERTICAL LOUVER

BRICKMOULD STYLE

Part Number Width (A) Height (B) Vent Area

DECORATIVE (NON-VENTING UNIT)

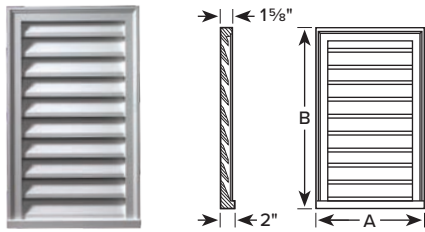

LV12X18	12"	18"	—
LV12X24	12"	24"	—
LV12X30	12"	30"	—
LV12X36	12"	36"	—
LV14X27	14"	27"	—
LV16X24	16"	24"	—
LV18X24	18"	24"	—
LV18X30	18"	30"	—
LV18X36	18"	36"	—
LV18X42	18"	42"	—
LV24X36	24"	36"	—

FUNCTIONAL (VENTING UNIT)

FLV16X24	16"	24"	21 Sq. In.
FLV18X24	18"	24"	24 Sq. In.
FLV18X30	18"	30"	31 Sq. In.

WITH 4F FLAT TRIM & 6" CROSSHEAD

Part Number Width (A) Overall Width (B) Height (C)

DECORATIVE (NON-VENTING UNIT)

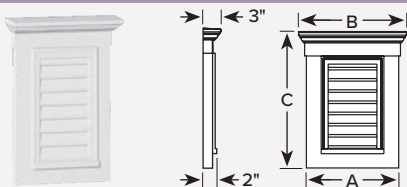

LV18X24-4F6WCH	26-1/2"	31"	33-1/2"
----------------	---------	-----	---------

LOUVERS

ROUND LOUVERS

BRICKMOULD STYLE

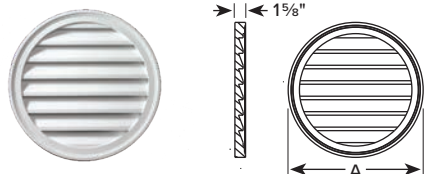

Part Number	Diameter (A)	Vent Area
-------------	--------------	-----------

DECORATIVE (NON-VENTING UNIT)

RLV18	18"	—
RLV22	22"	—
RLV24	24"	—
RLV28	28"	—
RLV30	30"	—
RLV36	36"	—

FUNCTIONAL (VENTING UNIT)

FRLV18	18"	12 Sq. In.
FRLV22	22"	22 Sq. In.
FRLV24	24"	27 Sq. In.
FRLV30	30"	46 Sq. In.

WITH DECORATIVE TRIM & KEYSTONES

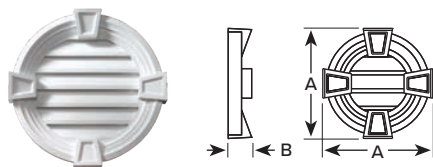

Part Number	Diameter	Overall Width/Height (A)	Projection (B)	Vent Area
-------------	----------	--------------------------	----------------	-----------

DECORATIVE (NON-VENTING UNIT)

RLV18MTK	18"	19-1/8"	3-5/8"	—
RLV24MTK	23-7/8"	25"	3-5/8"	—
RLV30MTK	30"	31-1/8"	3-5/8"	—
RLV32MTK	31-5/8"	33-1/4"	4-1/8"	—

FUNCTIONAL (VENTING UNIT)

FRLV18MTK	18"	19-1/8"	3-5/8"	4 Sq. In.
FRLV24MTK	23-7/8"	25"	3-5/8"	19 Sq. In.

WITH FLAT TRIM & FLAT KEYSTONE

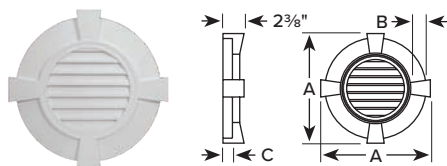

Part Number	Diameter	Overall Width/Height (A)	Trim Width (B)	Trim Thickness (C)
-------------	----------	--------------------------	----------------	--------------------

DECORATIVE (NON-VENTING UNIT)

RLV24-4FTK	31"	32-7/8"	3-1/2"	1"
------------	-----	---------	--------	----



ROUND LOUVERS (CONTINUED)

WITH FLAT TRIM & KEYSTONE

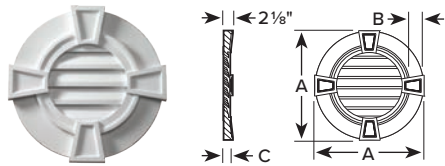

Part Number	Diameter	Width/Height (A)	Trim Width (B)	Trim Thickness (C)	Vent Area
DECORATIVE (NON-VENTING UNIT)					
RLV24TK	22-7/8"	24"	3-1/2"	1"	—
RLV30TK	28-7/8"	30"	3-1/2"	1"	—
RLV36TK	35"	36"	3-1/2"	1"	—
FUNCTIONAL (VENTING UNIT)					
FRLV24TK	22-7/8"	24"	3-1/2"	1"	10 Sq. In.

HALF-ROUND LOUVER

BRICKMOULD STYLE

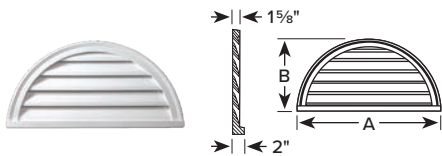

Part Number	Width (A)	Height (B)	Vent Area
DECORATIVE (NON-VENTING UNIT)			
HRLV36X18	36"	18"	—
FUNCTIONAL (VENTING UNIT)			
FHRLV36X18	36"	18"	28 Sq. In.
FHRLV48X24	48"	24"	55 Sq. In.

LOUVERS

OVAL LOUVER

BRICKMOULD STYLE

Part Number	Width (A)	Height (B)
-------------	-----------	------------

DECORATIVE (NON-VENTING UNIT)

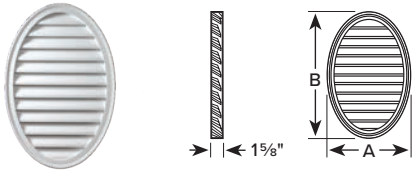

OVLV25X37V	24-1/2"	37"
------------	---------	-----

TWO-PIECE TRIANGLE LOUVER

BRICKMOULD STYLE

Part Number	Width (A)	Height (B)	Pitch (C)
-------------	-----------	------------	-----------

DECORATIVE (NON-VENTING UNIT)

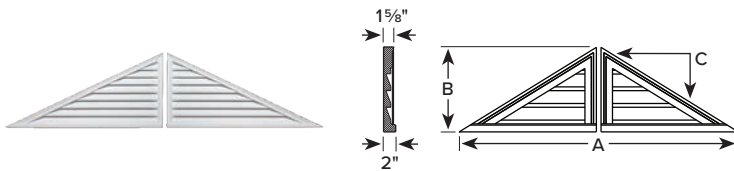

TRLVLR60X30	60"	30"	12/12
-------------	-----	-----	-------

TRIANGLE LOUVER

BRICKMOULD STYLE

Part Number	Width (A)	Height (B)	Pitch (C)
-------------	-----------	------------	-----------

DECORATIVE (NON-VENTING UNIT)

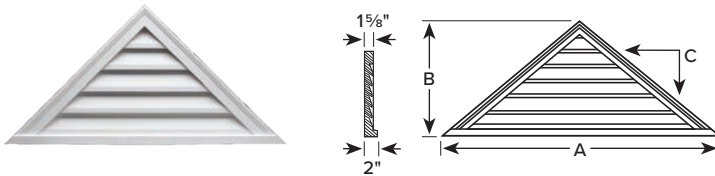

TRLV60X25	60"	25"	10/12
TRLV64X27	64"	26-1/2"	10/12
TRLV66X22	66"	22"	8/12



BALUSTRADE SYSTEMS

ADD OUTDOOR SOPHISTICATION.

Transform any porch, patio or balcony into an impressive outdoor living area. An eye-catching accent for many home designs, Fypon's Balustrade System is beautiful and durable.





A balustrade system is the combination of the railing (both at the top and bottom), newels (support posts on both sides of the rail section), and balusters (smaller posts between the newels) to form a decorative railing.

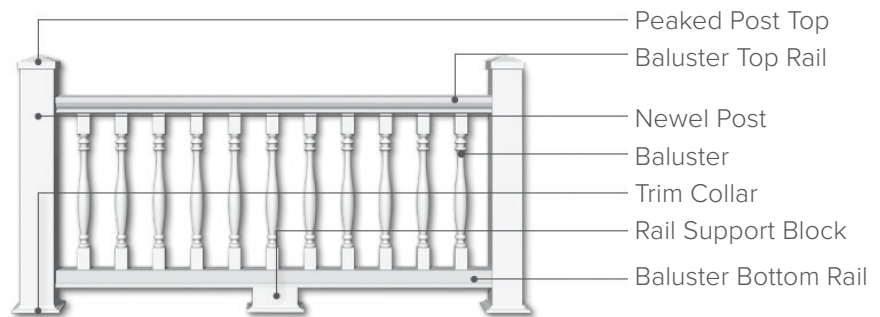

The railing design choice is an aesthetic option. For large spans of rail sections, a support block should be placed under the bottom rail so there is never more than 48" between posts. Each rail section will require two rail installation kits to connect the rail to each newel.

Newel posts will line both ends of each rail section. Each newel requires one Newel Post Installation Kit (NPK) to anchor the base of the post to the substrate. Additional accessories such as caps and trim kits can attach to the newels for an additional flair.

Most local building codes require that balusters be spaced in a way that a 4" ball cannot pass between them at any point. Each baluster design has a maximum center-to-center distance which will ensure that this building code is met. To determine the number of balusters, divide the rail length, in inches, by the center spacing dimension. Any fractional answers should be rounded up to the next whole number.

BALUSTRADE SYSTEMS

BALUSTERS

Part Number	Balustrade Rail System	A	B	C	D	E	F	Maximum Center-to-Center Distance
-------------	------------------------	---	---	---	---	---	---	-----------------------------------

ASHLEY

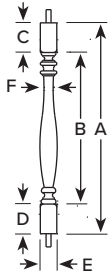

BAL3X24AY	5"	24"	15"	1-1/2"	4-1/2"	2-1/2"	1-3/8"	5-3/8"
BAL3X28AY	5"	28"	19"	4-1/2"	4-1/2"	2-1/2"	1-3/8"	5-3/8"
BAL3X32AY	5"	32"	23"	4-1/2"	4-1/2"	2-1/2"	1-3/8"	5-3/8"

BEAUMONT

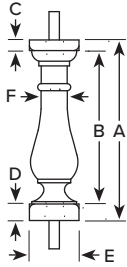

BAL5X19BE	7", 12"	19-1/8"	16-1/4"	1-1/8"	1-3/4"	5-1/4"	2-3/4"	6-3/4"
BAL5X22BE	7", 12"	22"	16-1/8"	2-1/8"	3-3/4"	5"	3-1/4"	7-1/8"

CLASSIC

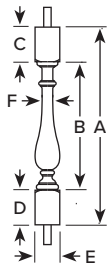

BAL5X20CC	7"	20"	10"	5"	5"	5"	3-5/8"	7-5/8"
BAL5X24CC	7"	24"	14"	5"	5"	5"	3-5/8"	7-5/8"
BAL5X28CC	7"	28"	18"	5"	5"	5"	3-1/2"	7-1/2"
BAL5X32CC	7"	32"	22"	5"	5"	5"	3-1/2"	7-1/2"
BAL5X28CC0B	7"	28"	21-1/8"	3-3/8"	3-3/8"	4-1/2"	2"	5-7/8"

LOGAN

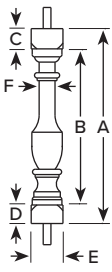

BAL3X28LN	5"	28"	22"	3"	3"	3"	1-1/2"	5-1/2"
-----------	----	-----	-----	----	----	----	--------	--------

BALUSTERS (CONTINUED)

Part Number	Balustrade Rail System	A	B	C	D	E	F	Maximum Center-to-Center Distance
-------------	------------------------	---	---	---	---	---	---	-----------------------------------

WOODRUFF

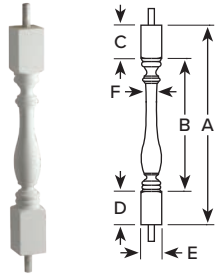

BAL3X18WF	5"	18"	10"	4"	4"	2-1/2"	1-3/8"	5-1/2"
BAL3X20WF	5"	20"	12"	4"	4"	2-1/2"	1-1/4"	5-1/4"
BAL3X24WF	5"	24"	16"	4"	4"	2-1/2"	1-1/4"	5-1/8"
BAL3X28WF	5"	28"	20"	4"	4"	2-1/2"	1-1/4"	5-1/8"

SQUARE

Part Number	Balustrade Rail System	Height (A)	Width (B)	Maximum Center-to-Center Distance
-------------	------------------------	------------	-----------	-----------------------------------

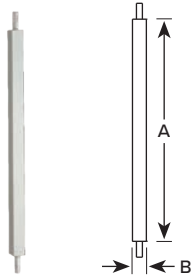

BAL2X20SQ	5"	20"	1-3/4"	5-3/4"
BAL2X28SQ	5"	28"	1-3/4"	5-3/4"









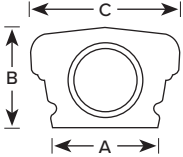

STRAIGHT RAILS

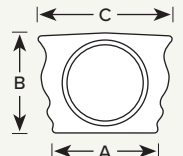
	Part Number	Balustrade Rail System	Length	Bottom Width (A)	Height (B)	Top Width (C)
--	-------------	------------------------	--------	------------------	------------	---------------

TOP STRAIGHT RAILS

						
	BTR5X96	5"	96"	3-1/4"	3-1/8"	4-5/8"
	BTR5X144	5"	144"	3-1/4"	3-1/8"	4-5/8"
						
	BTR7X96	7"	96"	5-1/2"	5-1/4"	7"
	BTR7X120	7"	120"	5-1/2"	5-1/4"	7"
	BTR7X144	7"	144"	5-1/2"	5-1/4"	7"

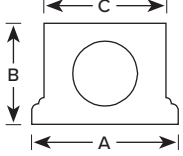
BOTTOM STRAIGHT RAILS

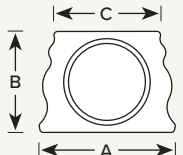
						
	BBR5X96	5"	96"	4-1/2"	3-1/8"	3-3/4"
	BBR5X144	5"	144"	4-1/2"	3-1/8"	3-3/4"
						
	BBR7X96	7"	96"	7"	5-1/4"	5-1/2"
	BBR7X120	7"	120"	7"	5-1/4"	5-1/2"
	BBR7X144	7"	144"	7"	5-1/4"	5-1/2"

INSTALLATION KITS

	Part Number	Balustrade System	Installation Notes
--	-------------	-------------------	--------------------

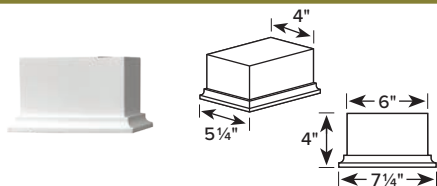

RSB4X4X6
Rail Support Block

5", 7", 12"

Install under the Bottom Rail at a span of 48" or less. Dimensions: 4" x 4" x 7-1/4" (may be trimmed for height).



BRK5
Rail Installation Kit

5"

Connects both ends of one 5" Top or Bottom Rail to support structure. Order two kits per section.

Kit Contents:
(2) Angle Brackets & Mounting Hardware



BRK6-7
Rail Installation Kit

7"

Connects both ends of one 7" Top or Bottom Rail to support structure. Order two kits per section.

Kit Contents:
(2) Angle Brackets & Mounting Hardware

BALUSTRADE SYSTEMS

NEWEL POSTS

Part Number	Balustrade System	Height (A)	Width (B)
-------------	-------------------	------------	-----------

CORNER PANEL

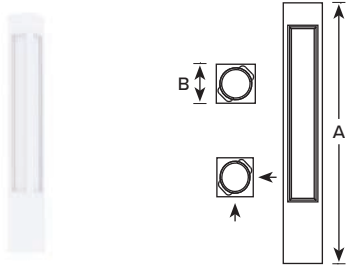

NPCP8X48	7"	48"	8"
----------	----	-----	----

PLAIN

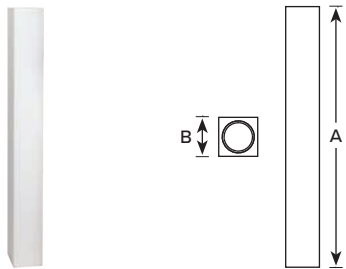

NP6X48	5"	48"	5-1/2"
NP8X48	7"	48"	7-1/2"

STRAIGHT PANEL

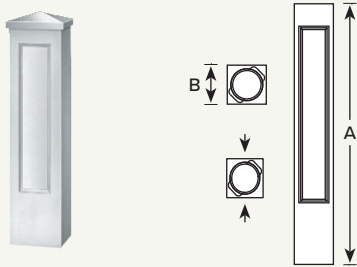

NPSP8X48	7"	48"	8"
----------	----	-----	----

INSTALLATION KITS

Installation Kit

Kit Contents

Newel Post Installation Kits are sold separately from the Newel Posts. Fasteners to mount steel base plate to the floor surface are not provided.

NPK400





Secures one 6" Newel Post to the structural substrate.

NPK600

Secures one 8" Newel Post to the structural substrate.

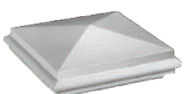
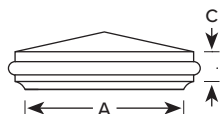

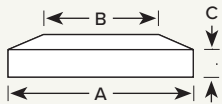
POSTS ACCESSORIES

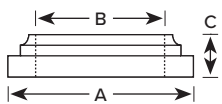
	Part Number	Balustrade System	Bottom Width (A)	Top Width (B)	Height (C)
FANCY PEAKED TOP					
 	PST6X6FP	5"	5-7/8"	—	2-1/8"
	PST8X8FP	7"	8-1/8"	—	3"
	PST9X9FP	7"	8-7/8"	—	3"
FLAT POST TOP					
 	PST7X7F	5"	6-1/2"	4-1/2"	1-1/2"
	PST10X10F	7"	9-1/2"	6-1/4"	2"
TRIM COLLAR					
 	TC6	5"	9-1/8"	5-5/8"	2"
	TC8	7"	11-1/8"	7-5/8"	2"
	TC8-8	7"	11-1/8"	8-1/8"	2"

INDEX

STYLE	PAGE	STYLE	PAGE	STYLE	PAGE
ADH1	71	BKT22X30X6S	48	CHT144X9	12
AR24X4F	18	BKT24X24X5	42	CHT36X6	12
AR36X4F	18	BKT25X25	40	CHT36X9	12
AR36X6F	18	BKT25X27	45	CHT48X6	12
AR48X4F	18	BKT28X30	40	CHT48X9	12
AR72X4F	18	BKT30X30	40	CLV12X24	54
B5X7	48	BKT31X30X5	40	CLV18X30	54
B6X8	48	BKT36X36	40	CLV22X31	54
B6X9	48	BKT36X36X4	45	CPCP50	14
BAL2X20SQ	63	BKT5X10	42	CPCP54	14
BAL2X28SQ	63	BKT5X4	43	CSP54	15
BAL3X18WF	63	BKT6X8	40	CSP80	15
BAL3X20WF	63	BKT7X11X3	41	CSP85	15
BAL3X24AY	62	BKT7X12X4	41	DMR457-10	19
BAL3X24WF	63	BKT8X15	42	DMST7X69	19
BAL3X28AY	62	BKT8X6	40	DSKD05F966K	23
BAL3X28LN	62	BKT8X8	40	DSKD05P966K	21
BAL3X28WF	63	BKT8X8X4	41	DSKD07F939	23
BAL3X32AY	62	BKT9X11	43	DSKD07F939K	23
BAL5X19BE	62	BMH6X8X60ELM-EC	51	DSKD07P939	21
BAL5X20CC	62	BMH6X8X72ELM-EC	51	DSKD07P939K	21
BAL5X22BE	62	BMH8X10X60ELM-EC	51	DSKD08F969K	23
BAL5X24CC	62	BMH8X10X72ELM-EC	51	DSKD08P969K	21
BAL5X28CC	62	BMR6X8X60CDR-EC	51	DSKS05F516	22
BAL5X28CC0B	62	BMR6X8X72CDR-EC	51	DSKS05F516K	22
BAL5X32CC	62	BMR8X10X60CDR-EC	51	DSKS05P516	20
BBR5X144	65	BMR8X10X72CDR-EC	51	DSKS05P516K	20
BBR5X96	65	BMRTSC4X6X24	50	DSKS07F569	22
BBR7X120	65	BMRTSC4X8X24	50	DSKS07F569K	22
BBR7X144	65	BMRTSL4X6X24	50	DSKS07P569	20
BBR7X96	65	BMRTSL4X8X24	50	DSKS07P569K	20
BKT10X10X9	41	BMRTST4X6X24	50	DSKS08F589	22
BKT10X11	41	BMRTST4X8X24	50	DSKS08F589K	22
BKT10X12	42	BRK5	65	DSKS08P589	20
BKT10X12X4	41	BRK6-7	65	DSKS08P589K	20
BKT10X16X4	43	BTR5X144	65	DSKS105F646	22
BKT11X15	42	BTR5X96	65	DSKS105F646K (10")	22
BKT11X16	42	BTR7X120	65	DSKS105F646K (12")	22
BKT11X20X6	45	BTR7X144	65	DSKS105F666	22
BKT11X20X8	45	BTR7X96	65	DSKS105F666K	22
BKT12X10	41	CAP50	14	DSKS105P646	20
BKT12X12GP	42	CAP54	14	DSKS105P646K (10")	20
BKT12X12X4	43	CAP75	14	DSKS105P646K (12")	20
BKT12X16	45	CAP80	14	DSKS105P666	20
BKT12X18X3X1S	46	CAP85	14	DSKS105P666K	20
BKT12X24X3	45	CHC11X6	12	DSKS107F679	22
BKT12X24X3S	48	CHC11X9	12	DSKS107F679K	22
BKT13X6	43	CHC2X6	12	DSKS107F689	22
BKT14X14	48	CHC2X9	12	DSKS107F689K	22
BKT14X16	42	CHC4X6	12	DSKS107P679	20
BKT14X16X4	45	CHC4X9	12	DSKS107P679K	20
BKT14X30X7.5S	46	CHC7X6	12	DSKS107P689	20
BKT15X18X6	40	CHC7X9	12	DSKS107P689K	20
BKT16X16	43	CHCCC4X9BT	13	DSKS108F699	22
BKT16X18X3	45	CHCCC6X9BT	13	DSKS108F699K	22
BKT16X18X4S	46	CHCCT144X9BT	13	DSKS108F709	22
BKT17X17	45	CHCCT36X9BT	13	DSKS108F709K	22
BKT18X18X4	43	CHCCT48X9BT	13	DSKS108P699	20
BKT18X24X3	42	CHCST144X6	13	DSKS108P699K	20
BKT18X24X4	45	CHCST144X8	13	DSKS108P709	20
BKT19X24X4	40	CHCST36X6	13	DSKS108P709K	20
BKT19X31	40	CHCST36X8	13	DSKS17F709	22
BKT19X36X4	40	CHCST48X6	13	DSKS17F709K	22
BKT20X24X5	40	CHCST48X8	13	DSKS17P709	20
BKT22X21	42	CHT144X6	12	DSKS17P709K	20

STYLE	PAGE	STYLE	PAGE	STYLE	PAGE
DSKS18F729	22	FLT153-12	28	MLD310-8	32
DSKS18F729K	22	FLT159-16	28	MLD313-8	32
DSKS18P729	20	FLT159-8	28	MLD320-12	33
DSKS18P729K	20	FLT162-8	28	MLD320-16	33
DSKS205F746	23	FLT170-12	28	MLD330-12	33
DSKS205F746K	23	FLT172-16	28	MLD331-16	34
DSKS205F786	23	FLT183-12	28	MLD332-8	33
DSKS205F786K	23	FLT186-16	28	MLD333-12	34
DSKS205P746	21	FLV16X24	55	MLD335-12	33
DSKS205P746K	21	FLV18X24	55	MLD336-16	33
DSKS205P786	21	FLV18X30	55	MLD350-8	32
DSKS205P786K	21	FRLV18	56	MLD351-8	32
DSKS207F779	23	FRLV18MTK	56	MLD353-8	32
DSKS207F779K	23	FRLV22	56	MLD354-12	32
DSKS207F819	23	FRLV24	56	MLD360-8	32
DSKS207F819K	23	FRLV24MTK	56	MLD362-16	33
DSKS207P779	21	FRLV24TK	57	MLD365-16	33
DSKS207P779K	21	FRLV30	56	MLD370-8	33
DSKS207P819	21	GP64X32	49	MLD371-16	30
DSKS207P819K	21	GPA70X35	49	MLD404-16	32
DSKS208F809	23	GPA81X34	49	MLD406-16	32
DSKS208F809K	23	GPA86X32	49	MLD410-12	33
DSKS208F849	23	GPA87X29	49	MLD411-16	33
DSKS208F849K	23	GPF66X33	49	MLD421-12	34
DSKS208P809	21	HRLV36X18	57	MLD430-12	33
DSKS208P809K	21	K10TM	10	MLD449-16	29
DSKS208P849	21	K4TF	10	MLD452-12	29
DSKS208P849K	21	K4TM	10	MLD453-16	29
DSKS25F846K	23	K6M	10	MLD454-12	29
DSKS25P846K	21	K6TF	10	MLD456-16	29
DSKS27F869	23	K6TM	10	MLD505-8	30
DSKS27F869K	23	K9M	10	MLD520-16	30
DSKS27P869	21	KP4TF	10	MLD527-16	30
DSKS27P869K	21	KP4TM	10	MLD552-12	29
DSKS28F889	23	KP6M	10	MLD555-12	30
DSKS28F889K	23	KP9M	10	MLD569-12	29
DSKS28P889	21	KWM180M	10	MLD572-16	29
DSKS28P889K	21	LDCH58X18	7	MLD584-16	29
DTLB3X3X3	46	LV12X18	55	MLD585-12	30
DTLB3X3X4	47	LV12X24	55	MLD593-16	29
DTLB4X4X4	47	LV12X30	55	MLD601-12	35
DTLB4X4X7	46	LV12X36	55	MLD610-8	35
DTLB4X5X7	47	LV14X27	55	MLD611-12	35
DTLB4X5X8	46	LV16X24	55	MLD612-12	35
DTLB4X6X7	47	LV18X24	55	MLD613-12	35
DTLB5X4X7	47	LV18X24-4F6WCH	55	MLD626-8	35
DTLB5X5X3	47	LV18X30	55	MLD634-16	35
DTLB5X6X11	47	LV18X36	55	MLD641-16	36
DTLB5X8	46	LV18X42	55	MLD649-16	35
DTLB6X4X6	47	LV24X36	55	MLD710-10	37
DTLB6X6X5	47	MLD207-16	37	NP6X48	66
DTLB6X6X8	47	MLD214-12	37	NP8X48	67
DTLB6X6X9	46	MLD215-12	37	NPCP8X48	66
DTLB8X6X6	47	MLD220-12	36	NPK400	66
DTLB9X8X8	46	MLD220-16	36	NPK600	66
EBLV18X30	55	MLD226-16	30	NPSP8X48	66
FHRLV36X18	57	MLD227-16	36	OV24X36X4F	19
FHRLV48X24	57	MLD231-12	37	OVLV25X37V	58
FLT109-12	28	MLD240-8	30	PB4X4	37
FLT110-16	28	MLD250-12	36	PB5X5	37
FLT113-8	28	MLD250-8	36	PB6X6	37
FLT118-8	28	MLD303-5	32	PIL11X108	17
FLT122-16	28	MLD304-8	32	PIL11X108DP	16
FLT152-12	28	MLD310-12	32	PIL11X108P	16
FLT152-8	28	MLD310-16	32	PIL11X120	17

INDEX

STYLE	PAGE	STYLE	PAGE	STYLE	PAGE
PIL11X90	17	SH2FP18X43	25	WCH200X9	8
PIL3X108	17	SH2FP18X47	25	WCH200X9K	9
PIL4X108	17	SH2FP18X51	25	WCH204X9	8
PIL4X86	17	SH2FP18X55	25	WCH24X6	6
PIL4X90	17	SH2FP18X59	25	WCH24X9	8
PIL5X108	17	SH2FP18X63	25	WCH25X9	8
PIL5X108P	16	SH2FP18X67	25	WCH28X6	6
PIL5X82	17	SH2FP18X71	25	WCH28X9	8
PIL5X90	17	SH3PC14X35RS	25	WCH30X6	6
PIL5X90DP	16	SH3PC14X39RS	25	WCH32X6	6
PIL5X90E	18	SH3PC14X43RS	25	WCH32X9	8
PIL5X90P	16	SH3PC14X47RS	25	WCH32X9K	9
PIL6X108	17	SH3PC14X51RS	25	WCH33X6	6
PIL6X120P	16	SH3PC14X55RS	25	WCH33X9	8
PIL6X144	17	SH3PC14X59RS	25	WCH33X9K	9
PIL6X90	17	SH3PC14X63RS	25	WCH34X6	6
PIL7X102	17	SH3PC14X67RS	25	WCH34X9	8
PIL7X108	17	SH3PC14X71RS	25	WCH35X6	6
PIL7X108P	16	SH3PC18X35RS	25	WCH35X9	8
PIL7X144	17	SH3PC18X39RS	25	WCH36X10BT	9
PIL7X90	17	SH3PC18X43RS	25	WCH36X6	6
PIL7X90DP	16	SH3PC18X47RS	25	WCH36X6K	6
PIL7X90E	18	SH3PC18X51RS	25	WCH36X9	8
PIL7X90P	16	SH3PC18X55RS	25	WCH36X9K	9
PIL8X108	17	SH3PC18X59RS	25	WCH37X6	6
PIL8X108P	16	SH3PC18X63RS	25	WCH37X6K	6
PIL8X90	17	SH3PC18X67RS	25	WCH37X9	8
PIL8X90P	16	SH3PC18X71RS	25	WCH37X9K	9
PIL9X102	17	SHMFH18X48	25	WCH38X6	6
PIL9X108	17	SHMFH18X60	25	WCH38X9	8
PIL9X108P	17	SHMFH18X72	25	WCH40X6	6
PIL9X90	17	SWDH32X16	15	WCH40X6K	6
PRS48X8	48	SWDH33X17	15	WCH40X9	8
PST10X10F	67	SWDH36X18	15	WCH40X9K	9
PST6X6FP	67	SWDH36X9	15	WCH41X6	6
PST7X7F	67	SWDH37X19	15	WCH41X9	8
PST8X8FP	67	SWDH40X20	15	WCH42X9	8
PST9X9FP	67	SWDH42X21	15	WCH43X6	6
RLV18	56	SWDH48X13	15	WCH43X9	8
RLV18MTK	56	SWDH48X24	15	WCH44X6	6
RLV22	56	SWDH60X30	15	WCH44X6K	6
RLV24	56	SWDH68X14	15	WCH44X9	8
RLV24-4FTK	56	SWDH72X14	15	WCH44X9K	9
RLV24MTK	56	SWDH72X36	15	WCH45X9	8
RLV24TK	57	SWDH76X15	15	WCH46X6	6
RLV28	56	SWDH76X38	15	WCH46X9	8
RLV30	56	TC6	67	WCH47X6	6
RLV30MTK	56	TC8	67	WCH48X10BT	9
RLV30TK	57	TC8-8	67	WCH48X6	6
RLV32MTK	56	TRLV60X25	58	WCH48X6K	6
RLV36	56	TRLV64X27	58	WCH48X9	8
RLV36TK	57	TRLV66X22	58	WCH48X9K	9
RSB4X4X6	65	TRLVLR60X30	58	WCH50X6	6
SH2FP16X35	25	WCH100X6	6	WCH50X9	8
SH2FP16X39	25	WCH100X9	8	WCH51X6	6
SH2FP16X43	25	WCH100X9K	9	WCH52X6	6
SH2FP16X47	25	WCH103X9	8	WCH54X10BT	9
SH2FP16X51	25	WCH104X6	6	WCH54X9	8
SH2FP16X55	25	WCH104X9	8	WCH56X6	6
SH2FP16X59	25	WCH104X9K	9	WCH56X9	8
SH2FP16X63	25	WCH108X6	6	WCH58X9	8
SH2FP16X67	25	WCH108X9	8	WCH60X6	6
SH2FP16X71	25	WCH144X6	6	WCH60X9	8
SH2FP18X35	25	WCH196X9	8	WCH64X6	6
SH2FP18X39	25	WCH197X9	8	WCH64X9	8

STYLE	PAGE	STYLE	PAGE	STYLE	PAGE
WCH66X6	6	WCH74X9	8	WCH84X6	6
WCH64X9K	9	WCH75X9	8	WCH84X9	8
WCH67X9	8	WCH76X6	6	WCH84X9K	9
WCH68X6	6	WCH76X9	8	WCH85X9	8
WCH68X9	8	WCH77X9	8	WCH86X9	8
WCH69X9	8	WCH78X6	6	WCH86X9T	10
WCH70X9	8	WCH78X9	8	WCH88X9	8
WCH72X6	6	WCH80X6	6	WCH93X9	8
WCH72X6K	6	WCH80X6K	6	WCH96X6	6
WCH72X9	8	WCH80X9	8	WCH96X9	8
WCH72X9K	9	WCH80X9K	9	WCH99X9	8
WCH73X6	6	WCH81X9	8	WDP36X18	19
WCH74X6	6	WCH82X9	8		

ADHESIVE

A urethane-based adhesive such as Loctite® PL Premium® Construction Adhesive must be used on all joints when installing urethane products. This will minimize the effects of expansion and contraction on the product. For additional information on adhesives, detailed installation instructions and finishing information, visit fypon.com.



Loctite® PL Premium®
Construction Adhesive - ADH1

CUTTING & MILLING

Fypon polyurethane products can be cut and trimmed with standard woodworking tools, including table saws, circular saws, jig saws, band saws and miter saws. Trimming product will remove the smooth finish and create an exposed polyurethane edge. This edge must be finished with paint or stain to protect the exposed polyurethane from discoloration from the sun. For more information on the installation and care of Fypon products, visit fypon.com.



A learning center for everything door related.

Buying a door unit doesn't need to be complicated and either should choosing the perfect millwork accessories to accompany it.

Visit the Learning Center at learn.reeb.com to learn more.



□ Bethlehem, PA
1000 Maloney Cir.
Bethlehem, PA 18015
(800) 862-8622 voice
(800) 772-7332 fax

□ Barclay, MD
1315 Goldsboro Rd.
Barclay, MD 21607
(800) 825-8331 voice
(800) 331-9387 fax

□ Mocksville, NC
346 Bethel Church Rd.
Mocksville, NC 27028
(800) 642-0886 voice
(800) 618-0620 fax

□ Providence, RI
19 Business Park Dr.
Smithfield, RI 02917
(800) 343-5703 voice
(800) 388-5979 fax

□ Syracuse, NY
7475 Henry Clay Blvd.
Liverpool, NY 13088
(800) 422-5224 voice
(800) 531-7332 fax



PART# REEBFYP22

VERSION 1.0.0