



WEATHER SHIELD® COLLECTION

WEATHER SHIELD®
WINDOWS & DOORS

YOUR DESIGN. YOUR VISION.

IN FULL VIEW





VUE

COLLECTION®

Modern design. Seamless engineering. The ultra-modern, all-aluminum VUE Collection makes sure nothing stands in the way of your home or your view.

The modular design of the VUE Collection is completely customizable. Windows can be combined easily to create walls of glass with ultra-narrow profiles, making the boundary between indoors and outdoors practically vanish.



THE BEST POINTS OF VUE



Ultra-Narrow Profiles

Maximize every view with super-thin profiles and industry-leading sizes that connect indoor living spaces with the outdoor spaces around them.

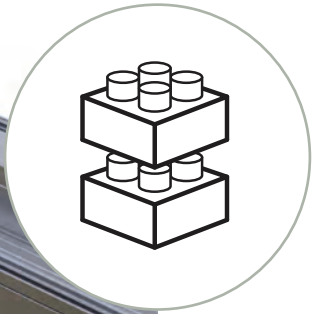
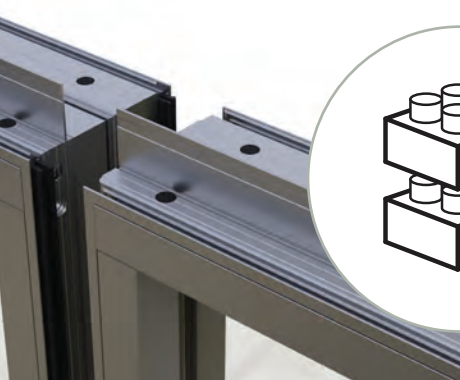

Integrated System

All VUE Collection products seamlessly connect with one another to create any custom combination of glass wall that can be imagined.



Design Flexibility

Every home design is unique. That's why we offer the most selections to help you achieve your vision. With the most design flexibility, the broadest product capability and widest availability of options, nothing is out of reach.



High-Performance Engineering

Each product is designed to maximize thermal and structural performance with the narrowest possible profile. Exceeding even the most stringent energy codes, the VUE Collection is engineered to perform.

O V E R V I E W

INSPIRED FORM. UNCOMPROMISED FUNCTION.

Unique structural integrity supports massive expanses of glass with ultra-narrow profiles while providing the exceptional thermal qualities of engineered aluminum.

Every window in the VUE Collection features thermally-broken aluminum to withstand the most severe weather conditions. The polyamide thermal breaks significantly reduce temperature transfer to deliver industry-leading thermal performance.

Get the look you've been longing for without sacrificing the performance you expect. Available in three distinctive form factors, the range of styles works with any home: Square Bead, Narrow Bead, and Beveled Bead.

CONSISTENT PROFILES

Fixed and operating units can be connected with a unique interlocking frame system.

NARROW SIGHTLINES

Allow for maximum views while still providing structural support for even the largest pieces of glass.



THERMAL INTEGRITY

EXTERIOR

Withstands the most severe conditions.

INTERIOR

Keeps things comfortable without wasting energy.

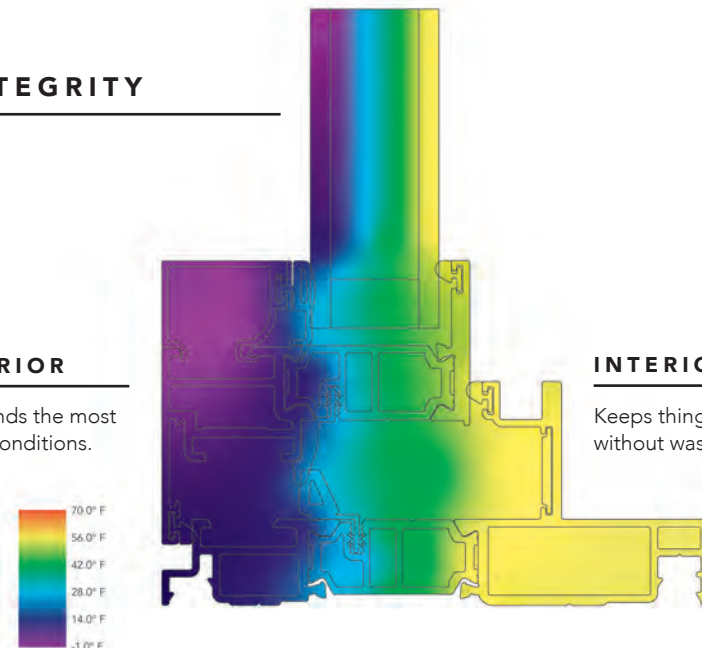



BALANCED

SQUARE BEAD

AESTHETIC

Modern design features clean, squared-off edges.

CONSTRUCTION

Precision butt-joined corners provide a consistent, polished look.

COMMON USE

Best for modern designs where balanced sightlines outweigh narrow proportions.



MINIMALISTIC

NARROW BEAD

AESTHETIC

An ultra-narrow sightline hides to accentuate the spans of glass.

CONSTRUCTION

Precision butt-joined corners provide a consistent, minimal look.

COMMON USE

Modern applications where narrow features and unobstructed views take precedence.



GRACEFUL

BEVELED BEAD

AESTHETIC

A soft appearance that highlights narrow profiles without sharp lines.

CONSTRUCTION

Precision miter corners deliver crisp, gap-free visuals.

COMMON USE

Soft-modern or transitional designs.

DIRECT-SET

MINOR PROFILES. MAJOR VIEWS.

An ultra-narrow profile maximizes views and natural light.

With one of the narrowest profiles available, our direct-set windows offer an ultra-narrow 2-11/16" mullion when combined with other direct-sets. They are available on their own or can seamlessly connect to other products and styles with our innovative mullion system.



IMAGE COURTESY OF RYANN FORD PHOTOGRAPHY

EXTERIOR GLAZING BEAD

Precision-cut joints minimize gaps. Three distinct profiles can complement any design aesthetic.

INNOVATIVE MULLION SYSTEM

Easily connect multiple windows to one another to create a seamless wall of glass.

INTEGRATED WEEP CHANNEL

A full-length kerf at the sill provides drainage without unsightly weep gates or exposed holes.

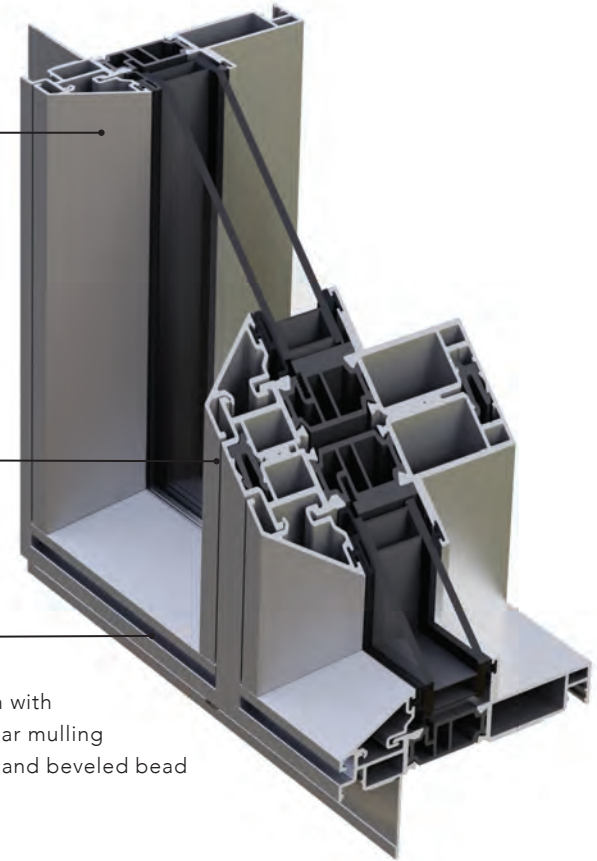

Shown with modular mullion frame and beveled bead



Shown with square bead

REFINED INTERIOR PROFILES

Thoughtfully simple interior profiles draw the eye to the view, not the framing.

5/8" JAMB FRAME

The narrow jamb face easily disappears into surrounding wall materials.

THERMALLY-BROKEN DESIGN

Advanced polyamide thermal strut is designed to deliver optimal thermal and structural performance capable of meeting the most stringent codes in North America.

C A S E M E N T

LET IN THE VIEWS AND THE BREEZES.

Generous views and wide-open ventilation. Our casement windows offer one of the narrowest sightlines in the industry to deliver more visible glass.

Industry-leading sizes and completely concealed hinges allow sashes to open with the cleanest interior and exterior aesthetic possible. They also seamlessly connect to other products and styles to help keep your space comfortable and energy-efficient year-round.



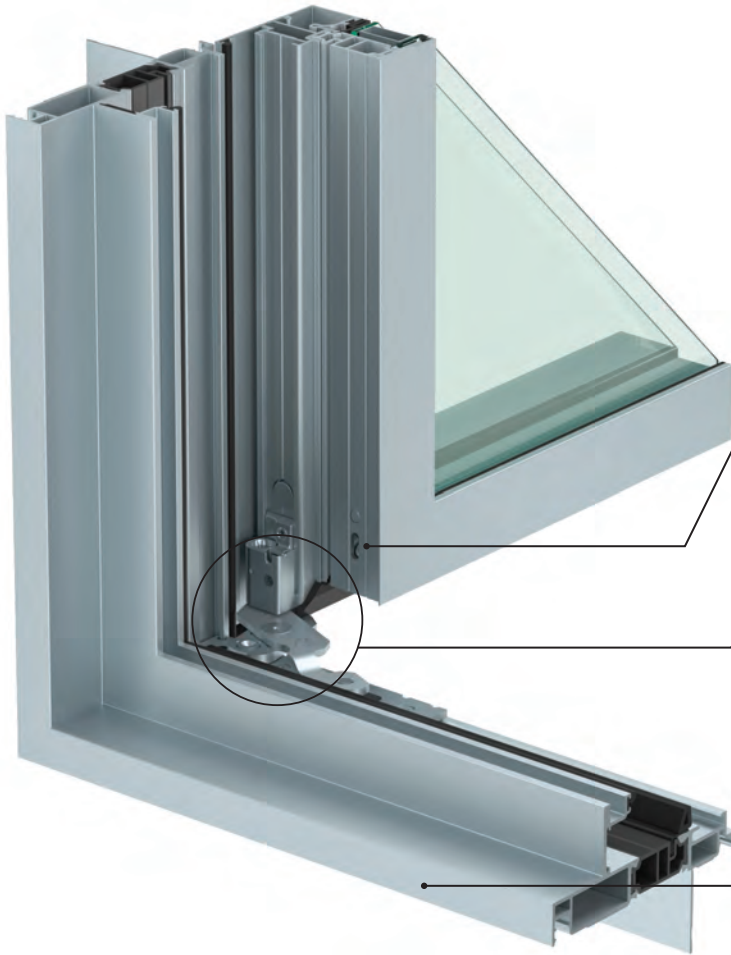

DURABLE CORNER KEYS

Mechanically fastened corners are kept square by cast metal corner keys. Corners are made water-tight by the injection of sealant in all corners.

CONCEALED HINGE

Completely concealed hinge provides the cleanest interior and exterior available. Hinges have a 320-lb weight capacity, allowing for industry-leading sizes up to 10' in height.

MINIMAL INTERIOR JAMB

The narrow jamb face easily disappears into surrounding wall materials.

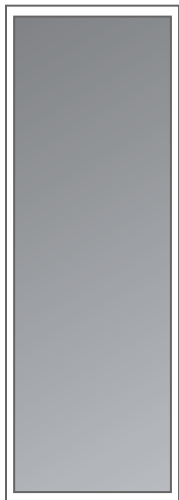

INDUSTRY LEADING VENTING SIZES

42" x 120"

A W N I N G S

FRESH AIR WITH REFRESHING FULL-WALL VIEWS.

Optimal for ventilation on sunny and rainy days alike, awning windows can be used alone or combined with other types of windows to create the aesthetics and functionality you desire.

The ideal way to add airflow and architectural beauty to your space. With an ultra-low visibility screen and the largest operating sash in the industry, awnings in the VUE Collection effectively deflect the most severe weather conditions while the 4-bar German hinges deliver years of hassle-free operation.





THERMALLY ADVANCED FRAME SYSTEM

Polyamide thermal break minimizes transference of temperature through the frame.

OVERLAPPING SASH DESIGN

The sash overlaps the frame and has three separate sealing points to keep out the elements.

COMMERCIAL GRADE 4-BAR HINGE

Corrosion-resistant stainless steel construction with an adjustable, self-balancing stay mechanism built in.



MULTI-SLIDE DOORS

INSIDE IS THE NEW OUTSIDE.

Moving glass walls open massive spans to create living spaces that flow effortlessly onto outdoor lounging areas.

Accent the connection between a home and its surroundings. Multi-slide doors offer the unique ability to open massive spans to the outdoors and create unforgettable spaces that let your imagination soar.



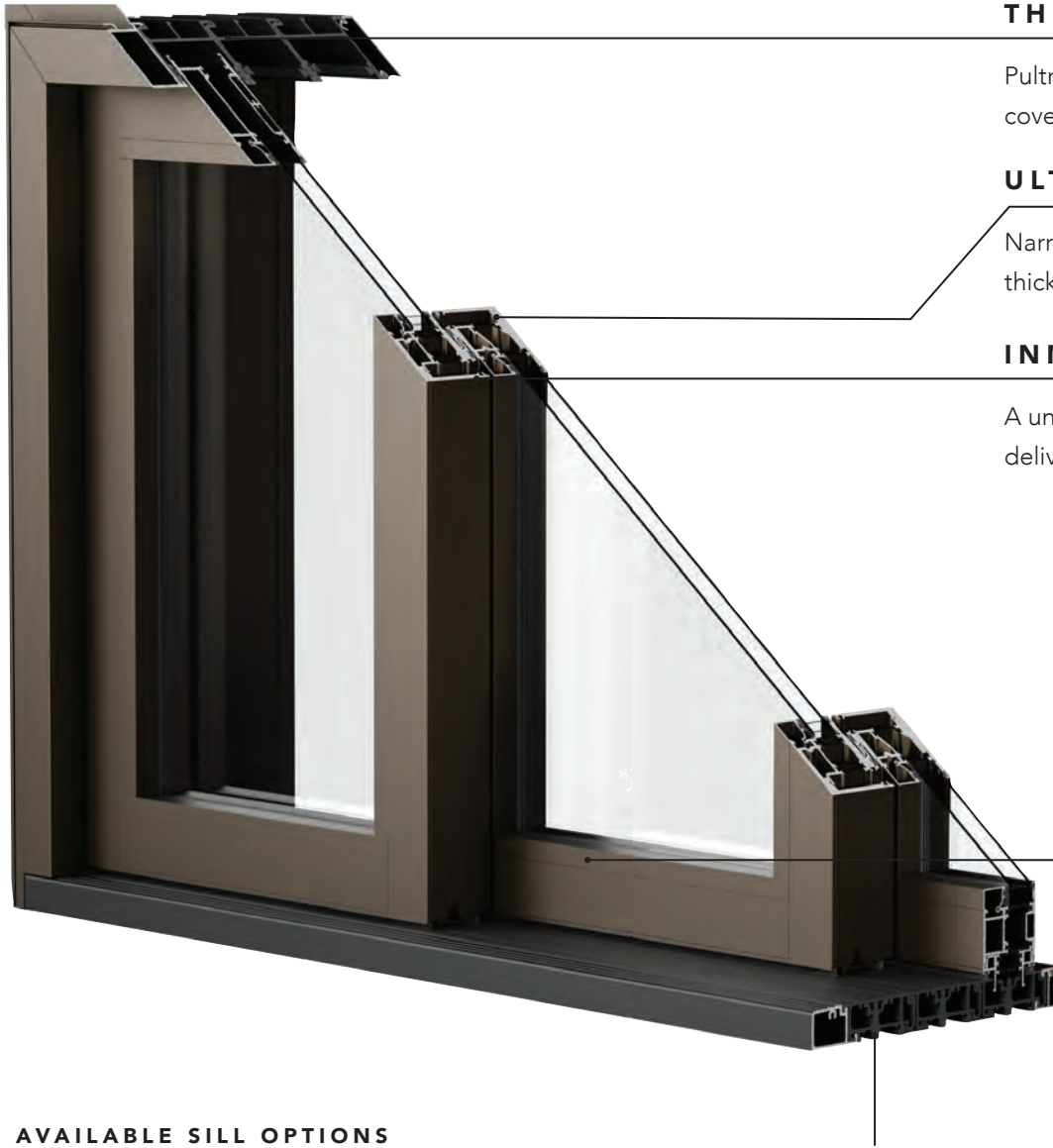

THERMALLY ADVANCED FRAME SYSTEM

Pultruded fiberglass sub-frame with aluminum interior and exterior covers provides optimal thermal efficiency.

ULTRA-NARROW STILE AND RAIL PROFILES

Narrow 2.5" wide stiles and rails maximize views while the 2.25" panel thickness ensures enduring strength.

INNOVATIVE THERMAL-BREAK DESIGN

A unique polyamide design helps prevent thermal bowing while delivering exceptional thermal and structural performance.



QUAD ROLLER

PRECISION BEARING QUAD ROLLERS

Eight precision bearing rollers per door panel deliver effortless operation even with the largest panels. Fully adjustable rollers ensure the highest levels of performance.

AVAILABLE SILL OPTIONS



STANDARD WEPT SILL 1.25"



STANDARD WEPT SILL WITH 1.5" RISER



STANDARD WEPT SILL WITH 2.5" RISER

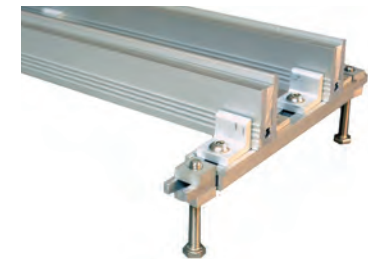

BARRIER-FREE SILL WITH OR WITHOUT DRAINAGE

COLORS

A FRAME WORTHY OF THE VIEW.

Pick from our curated color and finish options or color match to any custom colors you can imagine.

Whether you want windows that are nearly invisible or a powerful outline to elevate any picturesque landscape, we offer the color choices and customized options to make your views stunning. Architecturally-rated finishes will ensure your windows maintain their original appearance with minimal upkeep.



COLOR OPTIONS (INTERIOR AND EXTERIOR)

ANODIZED ALUMINUM FINISHES



RADIANT METALLIC



If you're looking for a truly original finish, choose from our custom color-match option.

12 STANDARD COLORS

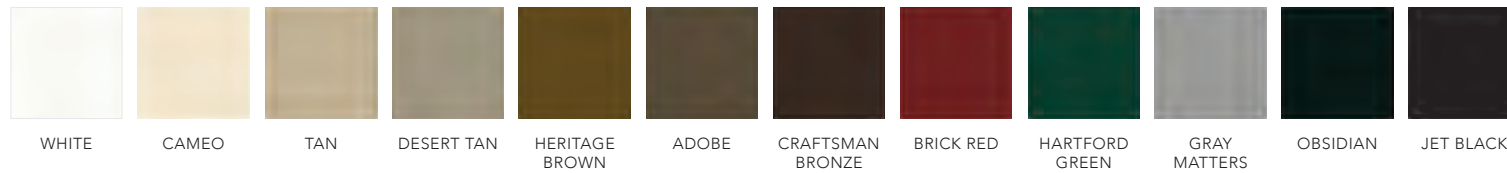

46 DESIGNER COLORS



TWO-TONE OPTIONS

Create a custom look by varying the interior and exterior colors.

* Standard Anodized Finishes

Finishes and colors shown may not be actual representations. Please visit authorized Weather Shield dealer for color samples.



H A R D W A R E

FIT FOR A PERSONAL TOUCH.

A minimal profile with maximum elegance. The variety of finish options guarantee every piece of hardware will blend seamlessly with your overall design.

To accompany the narrow profiles in the VUE Collection, each hardware option offers a complementary sleek design. Tested to withstand frequent use for years to come, intuitive latches and comfortable ergonomics make operation effortless.

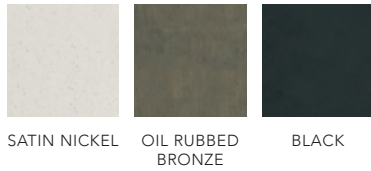

IMAGE COURTESY BY PDET PHOTOGRAPHY
DESIGNED & BUILT BY AIROOM ARCHITECTS BUILDERS & REMODELERS

CASEMENT AND AWNING HARDWARE OPTIONS AND FINISHES



MULTI-SLIDE DOOR HARDWARE AND FINISHES



EXTERIOR VIEW



INTERIOR VIEW



CONTEMPORARY
LOCK LEVER



CONTEMPORARY
NESTED HANDLE

CONCEALED SCREEN FRAME

A unique low-profile screen frame is completely concealed within a channel in the window. The high-visibility screen mesh delivers the highest screen cloth transparency available.

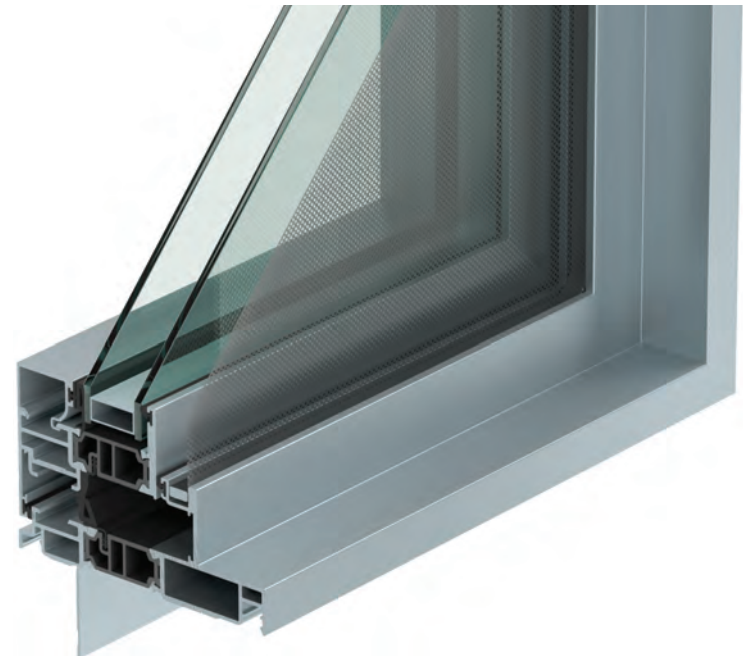

GLASS & DIVIDED LITES

TAILORED TO LIFE AND STYLE.

Designed to improve any home's energy efficiency, our glass options work to protect your home in any climate and enhance your comfort.

Meanwhile, Simulated Divided "Lites" (SDL) offer a custom, authentic look of true divided light without sacrificing energy efficiency.



GLASS OPTIONS

Choosing the right glass is critical for optimal performance, which is why the VUE Collection glazing options exceed even the most stringent energy codes. Black spacer bars minimize visual distractions while adding depth for a clean finishing touch.

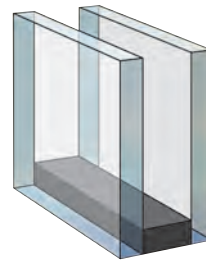
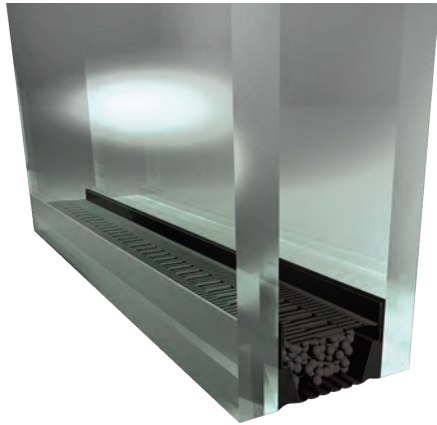

INSULATED LOW-E
ALL CLIMATE

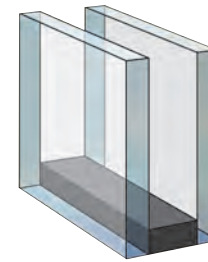

Zo-e-shield **5**
ULTIMATE SOLAR CONTROL

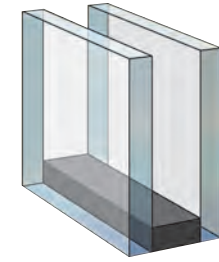

Zo-e-shield **SE**
PLUS ROOM SIDE LOW-E

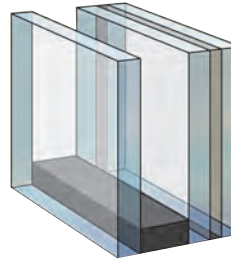

Zo-e-shield **6**
LAMINATED INTERIOR

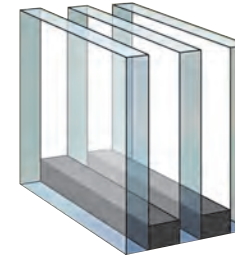

Zo-e-shield **7**
5 COATS OF LOW-E

SIMULATED STEEL APPEARANCE

Combine Beveled SDL and Beveled Bead for an authentic steel look with superior aluminum performance.

SIMULATED DIVIDED LITE (SDL) OPTIONS



7/8" BEVELED SDL BAR



7/8" SQUARE SDL BAR

Direct-set with
beveled bead
and bar



SERVICES & LOGISTICS

GREAT IDEAS.
IDEAL RESULTS.

From your initial design through the final installation, our team is ready to support you every step of the way.

Let us focus on what we do best so you can put your energy into what you do best. Our engineers, custom craftsmen and extensive support services are here to help you make decisions, streamline orders and create views you'd have to see to believe.

800.826.1608

vue.support@weathershield.com



IMAGE COURTESY OF KEITH ISAACS PHOTOGRAPHY



Design Assistance

Picking the right products for your application is essential to ensure the success of a project. Our technical specialists are here to provide you with drawings and specifications to help your vision become a reality.



Code Compliance

The VUE Collection products have been certified by an independent laboratory for thermal and structural performance. Our architectural support team will help with the selection of the right options to ensure compliance with even the most stringent codes.



Logistics

We work with our expert dealer partners and in-field installation teams to develop a logistics strategy that ensures our products are well protected and ready for installation.



Installation

Our network of trusted dealers work collaboratively with our manufacturing and your on-site team to ensure a seamless, high-quality installation. Included with every order, the VUE Collection Job Boxes contain all the smaller items you'll need for installation in one convenient place.

VUE
COLLECTION®

WEATHER SHIELD.
WINDOWS & DOORS

800.222.2995

WEATHERSHIELD.COM

©2022 Weather Shield Mfg, Inc.

1308904 – 04/22



IMAGE COURTESY BY PDET PHOTOGRAPHY
DESIGNED & BUILT BY AIROOM ARCHITECTS BUILDERS & REMODELERS