

Ready to trim anything?
So is Royal.



Contents

- 4 Introduction
- 6 **S4S**
PREMIUM TRIMBOARD™
- 8 **SurEdge™**
STANDARD TRIMBOARD
- 10 **Conceal™**
SPECIALTY TRIM
- 12 Precision Cut Trimboard
- 14 Sheet Board
- 16 Nickel Gap, Shiplap, Beadboard & Wainscoting
- 18 Column Wraps
- 20 Garage Door Trim System
- 22 Window & Door Moulding
- 24 Trim Visualizer & HomePlay™
- 25 Royal® Prefinished Trim
- 26 Mouldings



WINDOW TRIM, TRIMBOARD AND SIDING CORNER

Trim product lines that blend beautifully with every material and work for any project.

Details that transform homes and durability that defies time. When you're ready to build,

you need more than marketing claims.

You need the real deal.



ROYAL® SHEET BOARD, RAILING COMPONENTS, WINDOW & DOOR MOULDING

WE'LL HELP YOU KEEP YOUR PROMISES.

When it comes to building, remodeling and installing, all the details are important. We're ready when pros are, because we listen, learn and push the art and science of trim and moulding forward—making sure our product innovations anticipate and reflect what homeowners demand.

The result is getting our 100% cellular PVC trim products, components and features right, and you giving your customers the look they want—with maximum satisfaction and minimal maintenance. It's the difference between projects that are almost done and fully finished.



CONCEAL™ TRIM AND BEADBOARD

Royal® S4S Trimboard™

SMOOTH,
VERSATILE,
DURABLE.
FROM ALL SIDES.

Royal® S4S Trimboard™ makes virtually every build and remodel job a done deal. Its closed cell surface shrugs off dirt, while “true square” edges result in clean installations. It’s engineered with a Celuka-hybrid process that enhances durability. All in all, a compelling and architecturally correct way to embellish on, or completely transform, a homeowner’s exterior.

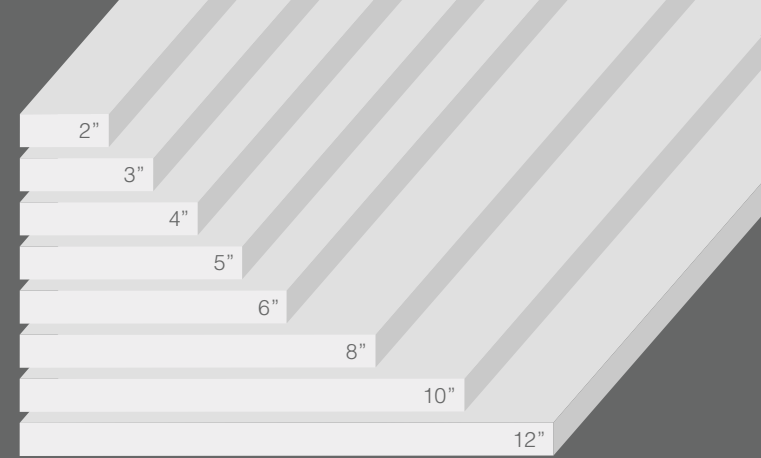

MULTIPLE WIDTHS

MULTIPLE THICKNESSES

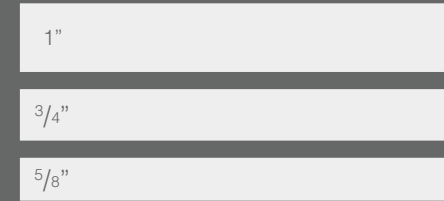

REVERSIBLE



ROYAL® COLUMN WRAPS AND S4S TRIMBOARD™

	Width	2"	3"	4"	5"	6"	8"	10"	12"
Thickness	Actual	1 1/2"	2 1/2"	3 1/2"	4 1/2"	5 1/2"	7 1/4"	9 1/4"	11 1/4"
5/8"	5/8"	•	•	•	•	•	•	•	•
1"	3/4"	•	•	•	•	•	•	•	•
5/4"	1"		•	•	•	•	•	•	•

- **Premium Celuka Hard Skin Trimboard**
- **Finishes available in Smooth and Smooth/Woodgrain Reversible.**
- **Standard Lengths 18' to 20'. Additional stocking and special order lengths available.**
- **Available in Tough Pack® and in bulk quantities. Check with local distributor or retailer for details.**

Royal® SurEdge™ Trimboard

SQUARE EDGES.
SHARP LOOKS.

SurEdge™ Trimboard gives you the ability to precisely define what your customers want to achieve with their homes, while keeping installs clean and tight. You can thank its crisp corners, low-maintenance 100% cellular PVC material and ability to complement a range of home styles—from Ranch to Colonial to Craftsman.



SUREEDGE™ TRIMBOARD

SurEdge™ Trimboard is available in two finishes:

SurEdge Protective Film



WOODGRAIN

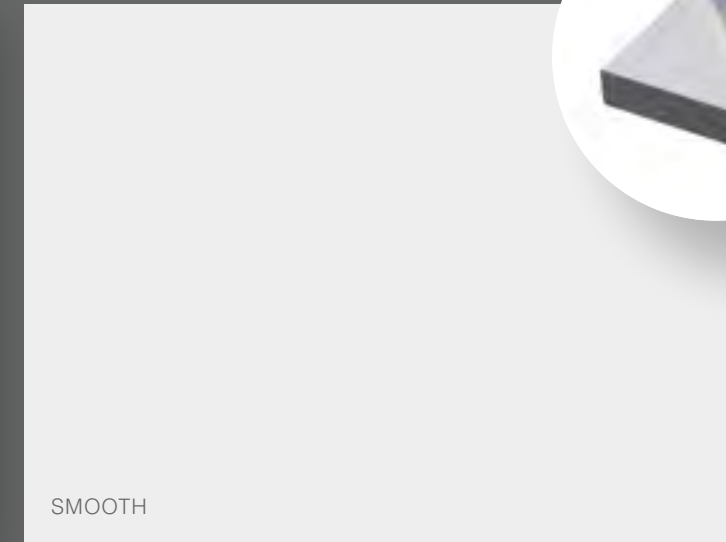

SMOOTH



	Width	3"	4"	5"	6"	8"	10"	12"	14"	16"
Thickness	Actual	2 1/2"	3 1/2"	4 1/2"	5 1/2"	7 1/4"	9 1/4"	11 1/4"	13 1/4"	15 1/4"
5/8"	5/8"		•	•	•	•	•	•	•	•
1"	3/4"	•	•	•	•	•	•	•	•	•
5/4"	1"	•	•	•	•	•	•	•		•

- **Sealed Square Edge Trimboard**
- **Finishes available in Smooth and Smooth/Woodgrain Reversible.**
- **Standard Lengths 12', 18' & 20'. Additional stocking and special order lengths available.**
- **Available in Tough Pack® and in bulk quantities. Protective Film available on popular sizes. Check with local distributor or retailer for details.**
- **Coming early 2019, Sand Dune colored SurEdge.**

Royal® Conceal™ Trim System





IT HAS VIRTUALLY EVERY SIDING COVERED.

The Royal® Conceal™ Trim System reveals itself as one of the best ways to complement virtually every kind of material, including Royal siding, of course. Its clean installs and architectural appeal make pros happy. And it rewards homeowners who appreciate long-lasting design statements that come with very little maintenance.









CONCEAL™ TRIM





CONCEAL OUTSIDE CORNERS

Profile	Description	Dimensions	1" Pocket		
9718	1x6 Traditional Corner	5 5/8" x 5 5/8"			
7971	5/4x4 Traditional Corner	3 1/16" x 3 1/16"			
7973	5/4x6 Traditional Corner	5 1/16" x 5 1/16"			
7972	5/4x4 Rabbeted Corner	3 1/16" x 3 1/16"	•		
7970	5/4x6 Rabbeted Corner	5 1/16" x 5 1/16"	•		





CONCEAL J-CHANNEL TRIM & WINDOW SURROUNDS

Profile	Description	Dimensions	1" Pocket		
9706	5/4x4 Rabbeted Trim	1" x 3 1/2"	•		
7994	5/4x6 Rabbeted Trim	1" x 5 1/2"	•		
9707	5/4x8 Rabbeted Trim	1" x 7 1/4"	•		

9794	5/4x4 New Construction Window Surround	1" x 3 1/2"	•		
9795	5/4x6 New Construction Window Surround	1" x 5 1/2"	•		
9800	5/4x4 New Construction Window Surround	1" x 3 1/2"			
9801	5/4x6 New Construction Window Surround	1" x 5 1/2"			

9816	1x4 New Construction Window Surround	3/4" x 3 1/2"			
9817	1x5 New Construction Window Surround	3/4" x 4 1/2"			
9818	1x6 New Construction Window Surround	3/4" x 5 1/2"			

CONCEAL T-MOULDS SMOOTH & WOODGRAIN

Profile	Description	Dimensions	1" Pocket		
9833	5/8x4 T-Mould	5/8" x 3 1/2"	•		
9835	5/4x4 T-Mould	1" x 3 1/2"	•		
9831	5/4x6 T-Mould	1" x 5 1/2"	•		
9832	5/4x8 T-Mould	1" x 7 1/4"	•		

For full product details, see the product directory.

Finishes available in Smooth or Woodgrain.

Precision Cut Trimboard

A METICULOUS FINISH.

Royal® Precision Cut Trimboard lends a pristine level of detail and standout presence to a variety of home styles. It's paintable, resists moisture and mold. Plus, it's available in woodgrain-embossed and smooth textures.



PRECISION CUT TRIMBOARD



PRECISION CUT TRIMBOARD

		Width									
		2"	3"	4"	5"	6"	8"	10"	12"	16"	
Thickness	Actual	1 1/2"	2 1/2"	3 1/2"	4 1/2"	5 1/2"	7 1/4"	9 1/4"	11 1/4"	15 1/4"	
3/8"	3/8"		•	•		•		•	•		
1/2"	1/2"			•		•	•	•	•	•	
5/8"	5/8"		•	•	•	•	•	•	•	•	
1"	3/4"	•	•	•	•	•	•	•	•	•	
5/4"	1"			•	•	•	•	•	•	•	
6/4"	1 1/4"			•		•	•	•	•	•	

- Finishes available in Smooth and Smooth/Woodgrain Reversible.
- Standard Lengths 18' & 20'. Additional stocking and special order lengths & widths available.
- Available in bulk pack quantities. Check with local distributor or retailer for details.

Royal® Sheet Board

CUT OUT FOR ANYTHING.

Some jobs demand more customization and flexibility than others. When you want to transform an idea into reality and truly make a project yours—from simple and modern to sophisticated and ornate—our Sheet Board suits the job perfectly. It mills and miters cleanly with standard tools and is available in 4' x 8' to 4' x 20' sheets.



Profile	Dimensions	Lengths					
		8'	9'	10'	12'	18'	20'
9912	1/4" x 4'	•		•	•		
2878	3/8" x 4'	•	•	•	•	•	•
2871	1/2" x 4'	•	•	•	•	•	
2838	5/8" x 4'	•	•	•	•	•	
2837	3/4" x 4'	•		•	•	•	•
2864	1" x 4'	•		•		•	
9752	1 1/4" x 4'	•		•	•	•	

- **Premium Sheet Board ± 1/32 Thickness Specification**
- **Finishes available in Smooth and Smooth/Woodgrain Reversible.**
- **Standard Lengths 8' 12' 18' & 20'. Additional special order lengths available.**
- **Available in bulk quantities. Check with local distributor or retailer for details.**

Nickel Gap, Shiplap, Beadboard & Wainscoting

OLD WORLD CHARM.
PVC TECH.

Introduce magnetic charm indoors and out, with Royal® Nickel Gap, Shiplap, Beadboard and Wainscoting trim. Our nickel gap or shiplap can give homeowners an entryway focal point or compelling living room feature, whether positioned in a traditional horizontal or a more contemporary vertical direction. Our beadboard lends sophistication to ceiling trim and crown moulding. And our wainscoting can add warmth to any room or hallway. What they all have in common: they're engineered to last with minimum upkeep.



ROYAL® 8" NICKEL GAP AND SHIPLAP



ROYAL® 6" NICKEL GAP AND SHIPLAP

Profile	Description	Dimensions
2352	5 1/2" Beaded Planking	3/8" x 5 1/2"
9734	6" Bead Board – Reversible	1/2" x 5 3/4"
9735	6" Bead Board Hi Heat – Reversible	1/2" x 5 3/4"
9830	6" Nickel Gap and Shiplap – Reversible	5/8" x 5 1/2"
9834	8" Nickel Gap and Shiplap – Reversible	5/8" x 7 1/4"

- Smooth finish
- Innovative Nickel Gap/ Shiplap joint – reversible application
- Standard Lengths 9' 12' 16'. Additional lengths available.
- Available in Tough Pack® and in bulk quantities. Check with local distributor or retailer for details.

Column Wraps

PRESENTING: THE PORCH

With their unique character and dimension, our column wraps, preassembled capitals and base kits give homeowners a unique way to magnify their curb appeal. They come in three distinctive styles—well-ornamented Traditional, purposeful Craftsman and contemporary Contractor.

All are virtually maintenance free and easy to install with standard tools.

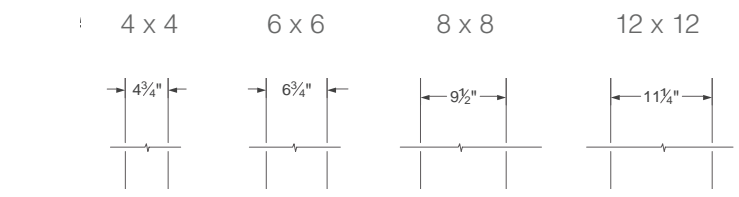

COLUMN WRAPS

Profile	Inside Dimension	Outside Dimension	Height	
			8'6"	10'
9807	3 3/4" x 3 3/4"	4 3/4" x 4 3/4"	•	•
9811	5 3/4" x 5 3/4"	6 3/4" x 6 3/4"	•	•
9815	8 1/2" x 8 1/2"	9 1/2" x 9 1/2"	•	•
9829	10 1/4" x 10 1/4"	11 1/4" x 11 1/4"	•	•

Contractor

Simple, unadorned lines complement the architecture of contemporary homes and siding styles.

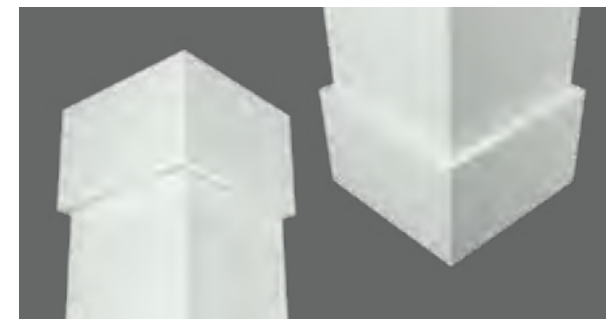

Traditional

A more ornate and "dressed" approach fits more traditional home styles, like the Colonial.



Craftsman

Straightforward and purposeful, this style perfectly matches the sturdy, practical impression of Craftsman-style homes.

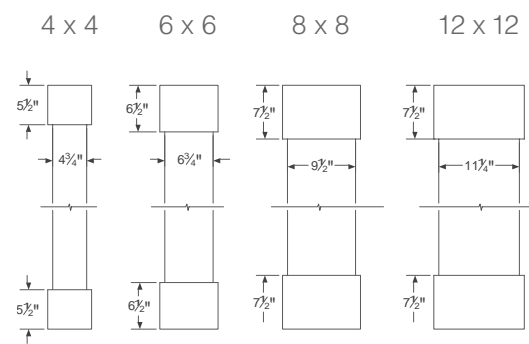

COLUMN CAP/BASE SET

Profile	Inside Dimension	Outside Dimension	Height
9854	4 7/8"	6 1/8"	5 1/2"
9855	5 7/8"	8 1/8"	6 1/2"
9856	8 1/2"	9 1/2"	7 1/2"
9857	10 1/4"	11 1/4"	7 1/2"

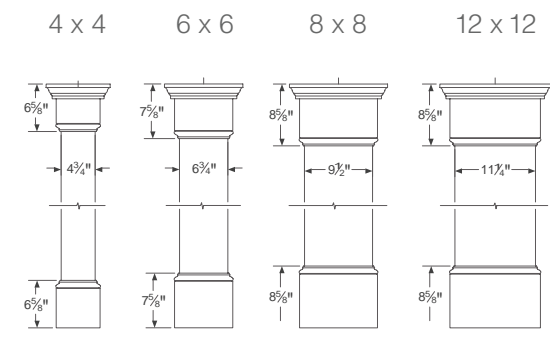

COLUMN CAP/BASE SET

Profile	Inside Dimension	Outside Dimension	Height
9850	4 7/8"	6 1/8"	6 5/8"
9851	5 7/8"	8 1/8"	7 5/8"
9852	8 1/2"	9 1/2"	8 5/8"
9853	10 1/4"	11 1/4"	8 5/8"

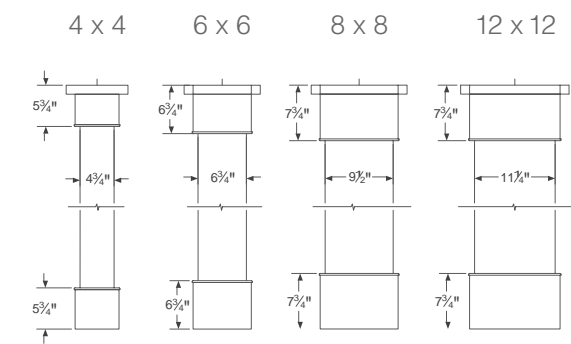

COLUMN CAP/BASE SET

Profile	Inside Dimension	Outside Dimension	Height
9858	4 7/8"	6 1/8"	5 3/4"
9859	5 7/8"	8 1/8"	6 3/4"
9860	8 1/2"	9 1/2"	7 3/4"
9861	10 1/4"	11 1/4"	7 3/4"

Garage Door Trim System

DESIGNED TO PROTECT AND PROJECT.

The Royal® Garage Door Trim System is engineered to separate garage interiors from dirt, bugs, wind, snow and water. Every component—brick mould, jamb and Uniflex™ garage door stop, which accommodates top and side mount applications—is designed to match virtually every garage style and color. It's all made from low-maintenance PVC.



ROYAL® GARAGE DOOR TRIM SYSTEM

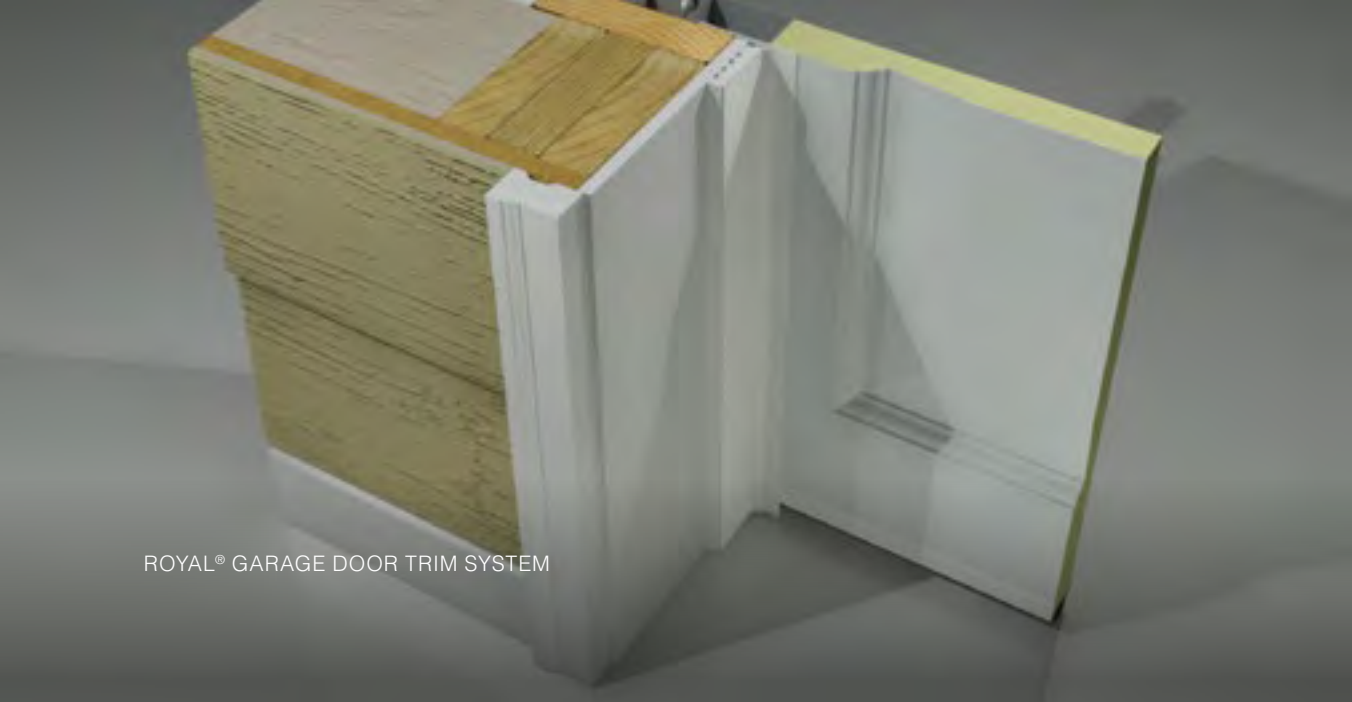

ROYAL® GARAGE DOOR TRIM SYSTEM

UNIFLEX™ GARAGE DOOR THERMOSTOP® & MOULDINGS

Profile	Description	Dimensions
9841*	Garage Door Trim	3/8" x 7 1/2"
2149	2" Standard ThermoStop	7/16" x 2"
3029	2 5/8" Retro Fit ThermoStop	7/16" x 2 5/8"
2591	3 1/4" Architectural ThermoStop	7/16" x 3 1/4"
2448*	Brick Mould	1 1/4" x 2"

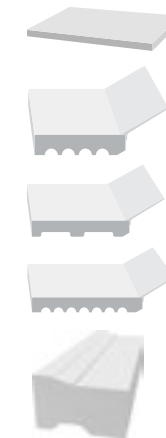

Standard lengths 7' to 18'.

Garage Door Stop packed in corrugated boxes. Check with local distributor or retailer for details.

*Contact customer service for color availability.

GARAGE DOOR THERMOSTOP TOP COLORS

We frequently update our palette to match the latest color trends. Here's a sampling of our most popular ones.



Minimum order quantities required. Speak with customer service for more details.

Window & Door Moulding

OUR FRAMING IS FORMIDABLE.

Window and door moulding has one job to do: look amazing for a very long time. Our components come in styles that match virtually every style of home, door and window. And because it's available in 100% cellular PVC, it protects against termites, moisture and extreme weather conditions, while demanding very little maintenance from homeowners.

BRICKMOULD & J-CHANNEL

Profile	Description	Dimensions
2448	RM 180 Brick Mould	1 1/4" x 2"
7351	RM 180 J-Channel Brick Mould	1 1/4" x 3"; 7/8" Pocket
7526	RM 180 Flat Back Brick Mould	1 1/4" x 2"
7252	Florida Brick Mould	3/4" x 1 5/8"
7216	Williamsburg Brick Mould	1 1/4" x 3 1/4"
7467	5/4x4 J-Channel Casing	1 1/8" x 4 1/2"

Premium Celuka Hard Skin Smooth finish. Lengths vary from 8' to 18' depending on style. Ask about our customer cut-to-length, mitering and fabrication. Check with local distributor or retailer for details.

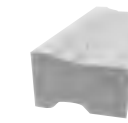

2448



7351



7526

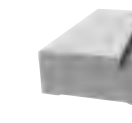

7252

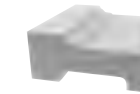

7216



7467

CROWN MOULDING

Profile	Description	Dimensions
2853	3" Crown – RM 53	9/16" x 2 3/4"
2435	4" Crown – RM 49	9/16" x 3 5/8"
7541	4 1/2" Crown – RM 48	1 1/16" x 4 1/4"
2592	5" Crown – RM 47	1 1/16" x 4 5/8"
7491	6" Crown – RM 45	9/16" x 5 1/4"
7662	8" Crown	1" x 8"
9824	8" Crown	1" x 7 1/2"
7158	Rams Crown	1 3/8" x 2 1/16"
7960	One Piece Crown	2 3/4" x 3 1/2"
7712	Deco Crown	1 1/2" x 1 7/8"

Smooth finish. Lengths vary from 8' to 16' depending on style. Check with local distributor or retailer for details.



2853



2435



7541



2592



7491



7662



9824



7158



7960



7712



WINDOW AND DOOR MOULDING

Trim Visualizer & HomePlay™

TRYING EXTERIOR ELEMENTS ON FOR SIZE (AND STYLE).

Our Royal® Trim Visualizer tool lets pros and homeowners coordinate various window and door trim styles with a full range of home styles, offering a vivid preview of how trim can truly finish a home. Our HomePlay™ by Royal® online design tool helps you mix and match a variety of exterior elements, starting by choosing from our pre-mapped selection of homes or uploading your own image. Create an account to save projects.

RoyalBuildingProducts.com/TrimVisualizer
HomePlayByRoyal.com

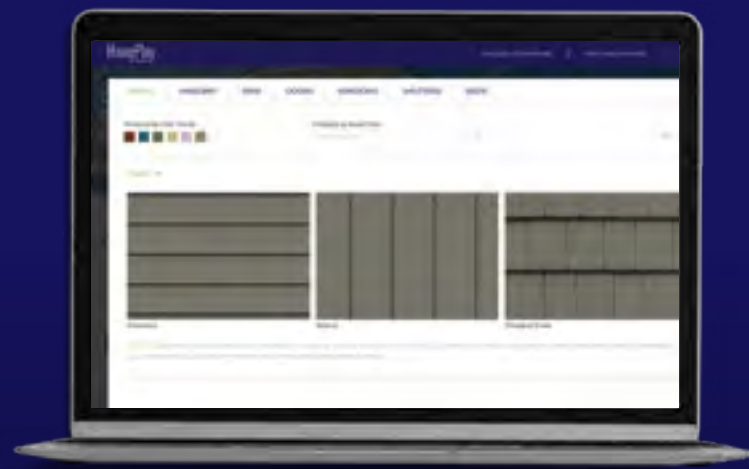
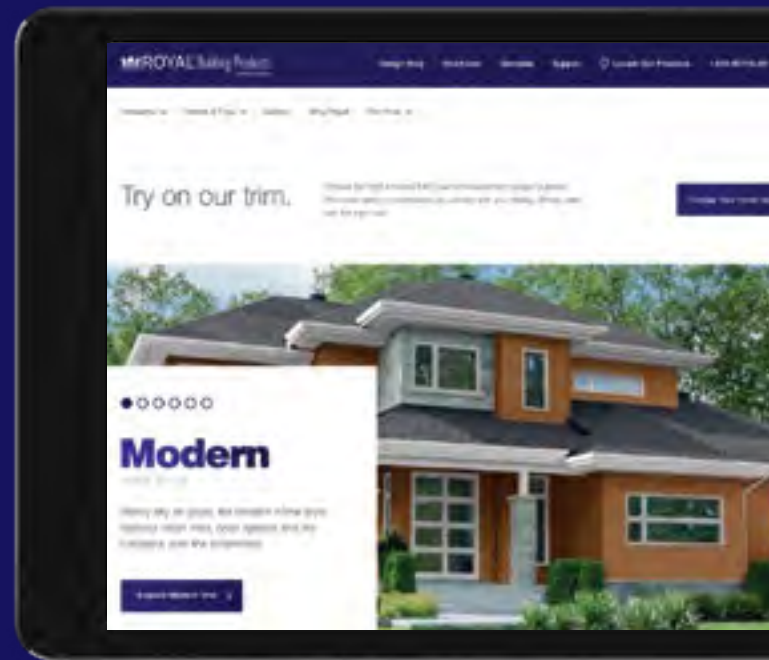

Royal® Prefinished Trim

ELEVATE VIRTUALLY EVERY STYLE.

Royal® Prefinished Trim combines the timeless curb appeal of real wood with the virtually maintenance-free properties of cellular PVC. Plus, its Kynar® factory-applied protective coating makes it highly durable, and keeps its broad selection of 15 colors true year after year, in all kinds of weather.



9775
SurEdge™ Trimboard
5/4" x 4", 16'

9779
SurEdge™ Trimboard
5/4" x 10", 16'

9777
SurEdge™ Trimboard
5/4" x 6", 16'

9780
SurEdge™ Trimboard
5/4" x 12", 16'

9778
SurEdge™ Trimboard
5/4" x 8", 16'

9767
SurEdge™ Trimboard
1" x 4", 16'

9771
SurEdge™ Trimboard
1" x 10", 16'

9769
SurEdge™ Trimboard
1" x 6", 16'

9782
SurEdge™ Trimboard
1" x 12", 16'

9770
SurEdge™ Trimboard
1" x 8", 16'

9759
SurEdge™ Trimboard
5/8" x 4", 16'

9762
SurEdge™ Trimboard
5/8" x 10", 16'

9760
SurEdge™ Trimboard
5/8" x 6", 16'

9763
SurEdge™ Trimboard
5/8" x 12", 16'

9761
SurEdge™ Trimboard
5/8" x 8", 16'

Mouldings

EXPAND WHAT'S POSSIBLE. INSIDE AND OUT.

Our mouldings have the ability to bring character not just to ceilings, walls and hallways, but porches, windows and doors. Plus, they're built to last, because they all share the same durable, low-maintenance properties that make life easy for homeowners.

DOOR JAMBS, SILL & SILL NOSES, TRANSOM, JAMB EXTENSIONS

Profile	Description	Dimensions
7717	Sill Nose	1 3/16" x 2"
7117	Sill	1 1/4" x 4 9/16"
7640	Sill Nose	2 1/4" x 2 3/4"
2345	Sill Nose	1 1/2" x 1 5/8"
7118	Sill Nose	1 3/8" x 1 5/16"
7435	Bull Nose Sill	1 3/4" x 2 3/8"
7631	Historic Sill Nose	1 3/4" x 2"
7181	4 9/16" Entry Door Jamb	1 1/4" x 4 9/16"
7241	6 9/16" Entry Door Jamb	1 1/4" x 6 9/16"
7464	Transom Sash	1 3/8" x 2 1/2"
7205	Jamb Extender	1 1/16" x 2 9/16"
7206	Jamb Extender	1 1/16" x 4 9/16"

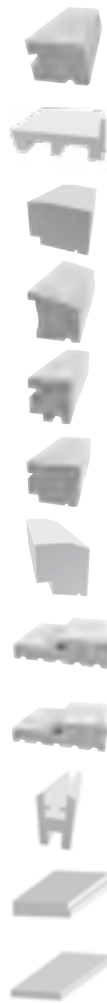

Premium Celuka Hard Skin Smooth finish.
Lengths vary from 7' to 18' depending on style.
Ask about our customer cut-to-length, mitering and fabrication.
Check with local distributor or retailer for details.









QUARTER ROUNDS, COVES AND LATTICE

Profile	Description	Dimensions
2024	Quarter Round RM 108	1/2" x 1/2"
5111	Quarter Round RM 107	5/8" x 5/8"
2689	Quarter Round RM 105	3/4" x 3/4"
2258	Bead Mould	3/8" x 1/2"
2021	Scotia Cove RM 93	3/4" x 3/4"
2046	Shoe Mould	5/16" x 3/4"
2330	Stop	5/8" x 5/8"
2349	Stop	9/16" x 1 1/4"
2850	Parting Bead	1/4" x 7/8"
2851	Parting Bead	1/4" x 1 1/8"
7788	Colonial Stop RM 947	3/8" x 1 1/4"
7719	Outside Corner RM 205	1 1/8" x 1 1/8"
5165	Outside Corner 1565	1 1/16" x 1 1/16"
6577	Outside Corner RM 206	1 1/16" x 1 1/16"
2450	Base Cap RM 164	1 1/16" x 1 1/8"
2759	Deco Trim	1/2" x 1"
2363	Screen Trim	3/4" x 1"
2018	Lattice	1/4" x 1 9/16"
6510	Lattice	1/4" x 1 3/4"







Smooth finish. Lengths vary from 7' to 17' depending on style. Check with local distributor or retailer for details.









DRIP CAPS, BACK BANDS & PANEL MOULD

Profile	Description	Dimensions		
2598	Bed Mould RM 75	9/16" x 1 9/16"		
2449	1 5/8" Drip Cap RM 197	1 1/16" x 1 5/8"		
2791	2" Drip Cap RM 187	1 1/16" x 2"		
7152	Back Band 3/4" Relief RM 412	1 3/8" x 1 7/16"		
7901	Shingle Band Mould RM 217	1 1/16" x 1 3/4"		
7202	Rake Mould RM 287	1" x 2"		Smooth finish
2599	Shingle Mould RM 210	1 1/16" x 1 5/8"		Lengths vary from 8' to 16' depending on style.
7714	Pediment	2" x 2 7/8"		Check with local distributor or retailer for details

RAIL & BALUSTERS

Profile	Description	Dimensions		
2536	Baluster	1 1/4" x 1 1/4"		
2542	Baluster	1 1/2" x 1 1/2"		Smooth finish
2535	Top Rail	1 1/2" x 3 5/16"		Lengths vary from 8' to 16' depending on style
2537	Bottom Rail	1 3/4" x 3 5/16"		Check with local distributor or retailer for details

CASING

Profile	Description	Dimensions	
2590	Back Band Casing 4 1/2"	1 3/16" x 4 1/2"	
2852	New Adams Casing 3 1/2"	1" x 3 1/2"	
7216	Williamsburg Casing 3 1/4"	1 1/4" x 3 1/4"	
2369	RB3 Casing 3 1/2" RM 523	1" x 3 1/2"	
5445	Colonial Casing 2 1/4" LRM 356	5/8" x 2 1/4"	
2342	Casing 2 1/4" RM 376	1 1/16" x 2 1/4"	
2355	Colonial Casing 2 1/4" RM 356	1 1/16" x 2 1/4"	
5913	Ranch Casing 2 1/4" RM 328	9/16" x 2 1/4"	
2343	Colonial Casing 3 1/4" RM 445	5/8" x 3 1/4"	

Smooth finish

Lengths vary from 7' to 17' depending on style.

Check with local distributor or retailer for details

BASE & CHAIR RAIL

Profile	Description	Dimensions
5106	Ranch Base	7/16" x 2 1/2"
6761	Base/Casing Combo	1/2" x 2 3/4"
5523	Colonial Base LRM 623	7/16" x 3 1/4"
7527	Base RM 623	7/16" x 3 1/4"
7861	Heirloom Base	7/16" x 5"
6610	Royal Base	1 1/16" x 5 1/4"
9789	Column Wrap Base	5/8" x 8 7/16"
5390	Chair Rail RM 390	1 1/16" x 2 5/8"

Smooth finish

Lengths vary from 7' to 17' depending on style.

Check with local distributor or retailer for details



WM CROSS REFERENCE

WM® Series	RM Series	Royal Profile	Description	Dimensions	Page #
WM45	RM45	7491	6" Crown	9/16" x 5 1/4"	22
WM47	RM47	2592	5" Crown	1 1/16" x 4 5/8"	22
WM49	RM49	2435	4" Crown	9/16" x 3 5/8"	22
MW48	RM48	7541	4 1/2" Crown	1 1/16" x 4 1/4"	22
WM53	RM53	2853	3" Crown	9/16" x 2 5/8"	22
WM75	RM75	2598	Bed Mould	9/16" x 1 7/8"	28
WM93	RM93	2021	Scotia Cove	3/4" x 3/4"	27
WM105	RM105	2689	Quarter Round	3/4" x 3/4"	27
WM107	RM107	5111	Quarter Round	5/8" x 5/8"	27
WM108	RM108	2024	Quarter Round	1/2" x 1/2"	27
WM142	RM142	7152	Back Band 3/4" Rabbet	1 3/8" x 1 7/16"	28
WM164	RM164	2450	Base Cap	1 1/16" x 1 1/8"	27
WM180	RM180	2448	Brick Mould	1 1/4" x 2"	21
WM187	RM187	2791	2" Drip Cap	1 1/16" x 2"	28
WM197	RM197	2449	1 5/8" Drip Cap	1 1/16" x 1 5/8"	28
WM205	RM205	7719	Outside Corner	1 1/8" x 1 1/8"	27
WM206	RM206	6577	Outside Corner	1 1/16" x 1 1/16"	27
WM210	RM210	2599	Shingle Mould	1 1/16" x 1 5/8"	28
WM217	RM217	7901	Shingle Band Mould	1 1/16" x 1 3/4"	28
WM287	RM287	7202	Rake Mould	1" x 2"	28
WM328	RM328	5913	Ranch Casing	9/16" x 2 1/4"	29
LWM356	LRM356	5445	Colonial Casing	5/8" x 2 1/4"	29
WM356	RM356	2355	Colonial Casing	1 1/16" x 2 1/4"	29
WM376	RM376	2342	Casing	1 1/16" x 2 1/4"	29
WM390	RM390	5390	Chair Rail	1 1/16" x 2 5/8"	30
WM445	RM445	2343	Colonial Casing	5/8" x 3 1/2"	29
WM523	RM523	2369	RB3 Casing	1" x 3 1/2"	29
WM623	RM623	7527	Base RM 623	7/16" x 3 1/4"	30
LWM623	LRM623	5523	Colonial Base	7/16" x 3 1/4"	30
WM947	RM947	7788	Colonial Stop	3/8" x 1 1/4"	27

"RM" designation identical or similar to WM® Series Patterns.

Some RM Series non-stocking.

Royal® Building Products exists for one reason: to push the limits of what every type of exterior can be. We strive for best-in-class manufacturing and industry-leading innovation. What drives us? Every homeowner who demands exteriors that add value, perform impeccably, look amazing and make their lives easier. Our goal is to bring more products, more styles, more technology, more design insight and more sustainable solutions to the attention of everyone who cares about creating the best exterior possible. Build Royal™

Build™



CELECT® CELLULAR COMPOSITE SIDING



ROYAL® TRIM & MOULDINGS



ROYAL® VINYL SIDING



HAVEN® INSULATED SIDING



ROYAL® SHUTTERS, MOUNTS & VENTS

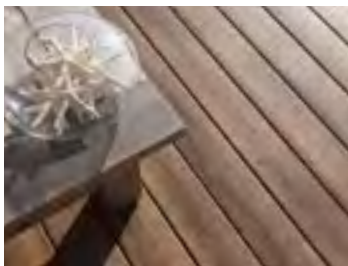

ZURI® PREMIUM DECKING



CEDAR RENDITIONS™ ALUMINUM SIDING



PORTSMOUTH™ SHAKE & SHINGLES

